



# MSA ABRASI-BLAST™ ABRASIVE BLASTING RESPIRATOR



**PART NUMBERS AND SCHEMATICS GUIDE**

## Company Profile

Allredi was formed in the early 2020, when two of the largest distributors in the blasting, coating, safety, and environmental industry, APE Companies and Marco Group International, joined forces. While the qualities both companies are known for have not changed, a lot about our business is new. New abilities. New agilities. New ways to help you win. This calls for a new name, Allredi.

This name exemplifies what we have become. It is completely oriented to the needs of our customers. To your needs. It says that when you call us for anything – products, service, expert advice, anything – you can consider it done. Or even better, Allredi done.

We are your right-now supplier. From skills to SKUs, we deliver the goods fast. So you can be more agile every minute, every day. This is who we are. This is what our new name means. Go ahead and expect excellence, because we're bringing it.

## The Allredi Difference

- **Industry Experience** – With Allredi on your team, you have access to expertise which can only come from decades of industry leadership. We have organized our engineering department, production specialists, customer operations, and safety support into a "Center of Competence." As an Allredi customer, you have access to hundreds of years of cumulative experience related to your operations.
- **Manufacturing Excellence** – Allredi is a U.S. based manufacturer of equipment for the Surface Preparation and Protective Coatings industries. Allredi's engineers benchmark the industry to ensure that we design and manufacture superior products that set the "Gold Standard" for performance, safety, and quality.
- **Legendary Customer Service** – Allredi's legendary customer service team is staffed by friendly, highly-trained individuals who are focused on providing the highest level of product support, order accuracy, and customer satisfaction.
- **Product Availability** – We stock over 10,000 SKU's and have over 45 shipping locations to serve North American and International markets for all major brands of blasting, coating, environmental, and safety equipment. Allredi is your right-now supplier, so you can keep your projects moving. From our foundation of strong relationships, we have built a nationwide network that puts vast inventory and ready service close to our customers. We provide advanced expertise, and we deliver the goods fast – so you can easily access the products and services you need to me more agile every minute, every day.
- **Technology Leadership** – Our website provides: Operator's Manuals, Part Numbers and Schematics Guides, SDS information, and key product features and specifications, providing access to information 24/7.

# TABLE OF CONTENTS

<b>Table of Contents</b> .....	<b>3</b>
<b>MSA Abrasi-Blast™ Abrasive Blasting Respirator</b> .....	<b>4-11</b>
Part Numbers .....	4
Lens Cartridges .....	5
Hoods .....	6
Internal Repair Parts .....	7
Facepiece Assembly Part Numbers & Schematics .....	8-9
Optional Accessories .....	10
Breathing Line .....	11
Quick-Disconnect Fittings .....	12-14
<b>Maintenance Notes</b> .....	<b>15</b>

## PART NUMBERS

### MSA ABRASI-BLAST™ ABRASIVE BLASTING RESPIRATORS

<b>Part Numbers</b>	<b>Working Pressure</b>	<b>Quick-Disconnect Style</b>	<b>HOOD</b>	
			<b>Material</b>	<b>Length</b>
<b>10MSA468720</b>	10 – 15 psi	Snap-Tite®	Hepalon	Shoulder
<b>10MSA468726</b>	10 – 15 psi	Snap-Tite®	Hepalon	Waist
<b>10MSA468722</b>	35 – 40 psi	Snap-Tite®	Hepalon	Shoulder
<b>10MSA468718</b>	35 – 40 psi	Snap-Tite®	Hepalon	Waist



## LENS CARTRIDGES

		MSA FACEPIECE ASSEMBLY PROTECTIVE LENS CARTRIDGES		
		Part Numbers	Thickness	Lens
	10MSA473798	.09	Untempered	12 Cartridges; 3 Lenses per Cartridge
	10MSA473800	.09	Tempered	12 Cartridges; 3 Lenses per Cartridge
	10MSA473802	.12	Untempered	12 Cartridges; 2 Lenses per Cartridge
	10MSA481742	.12	Untempered	12 Cartridges; 3 Lenses per Cartridge

# ABRASI-BLAST™ HOODS

Part Numbers	ABRASI-BLAST™ ABRASIVE BLASTING RESPIRATOR HOODS	
	Material	Length
10MSA468725	Hepalon	Shoulder
10MSA468724	Hepalon	Waist
10MSA480699	Duck Cloth	Chest
10MSA486303	Neoprene	Waist
10MSA486329	Knit Back, Hypalon Front	Shoulder

Facepiece and Breathing Tubes not included



10MSA468725



10MSA468724

# ABRASI-BLAST™ HOOD ACCESSORIES

Part Numbers	ABRASI-BLAST™ ABRASIVE BLASTING RESPIRATOR HOOD ACCESSORIES
	Description
10MSA468705	Replacement Collar Assembly
10MSA465626	Hood Plug ( <i>For use when breathing tube worn inside hood</i> )
10MSA473902	Vinyl Belt
10MSA9961	Web Belt



10MSA468705



10MSA473902  
10MSA9961

## PART NUMBERS & SCHEMATICS

### MSA Facepiece Assembly

Item #	Part #	Description
<b>Fig. 2</b>		
1	10MSA491125	Valve Disc
2	10MSA491124	Valve Seat <i>(Two Required)</i>
3	10MSA471710	Nosecup Assembly – Small
—	10MSA471711	Nosecup Assembly – Medium
—	10MSA471712	Nosecup Assembly – Large
4	10MSA458173	Harness
5	10MSA457190	Buckle Assembly with D-Ring <i>(Two Required)</i>
6	10MSA470909	Lens Ring – Small <i>(Gray, Two Required)</i>
—	10MSA462709	Lens Ring – Medium <i>(Black, Two Required)</i>
—	10MSA470910	Lens Ring – Large <i>(Gold, Two Required)</i>
7	10MSA10087006	Lens Housing
8	—	Lens Cartridge Assembly <i>(See Page 5)</i>
9	10MSA60532	Screw <i>(Two Required)</i>
10	10MSA628210	Clamp
11	10MSA9666	Retainer Ring
12	10MSA488875	Speaking Diaphragm
13	10MSA629935	O-Ring
14	10MSA470039	Inlet Housing
15	10MSA813103	Disc Valve
16	10MSA491934	Gasket and Valve Spider
17	10MSA96547	Adapter Assembly
18	10MSA3532	Gasket <i>(Two Required)</i>
19	10MSA57909	Clamp <i>(Two Required)</i>
20	10MSA84930	Threaded Insert for 20" Breathing Tube 10MSA470734
—	10MSA475279	Threaded Insert for 28" Breathing Tube 10MSA457158
21	10MSA470734	20" Breathing Tube
—	10MSA457158	28" Breathing Tube
22	10MSA15756	Coupling Nut
23	10MSA17554	Breathing Tube Insert for 20" Breathing Tube 10MSA470734
—	1071591	Breathing Tube Insert for 28" Breathing Tube 10MSA457158
24	10MSA82382	Exhalation Valve <i>(Two Required)</i>
25	10MSA78703	Exhalation Flapper Valve <i>(Two Required)</i>
26	10MSA461958	Exhalation Valve Body <i>(Two Required)</i>
27	10MSA462185	Exhalation Valve Assembly <i>(Include Item #'s: 24, 25, and 26)</i>
—	10MSA454819	Prescription Spectacle Kit <i>(Not Shown)</i>
—	106M441	Part Numbers & Schematics Guide – MSA Abrasi-Blast™ Abrasive Blasting Respirator



# PART NUMBERS & SCHEMATICS

Figure 2: MSA Facepiece Assembly

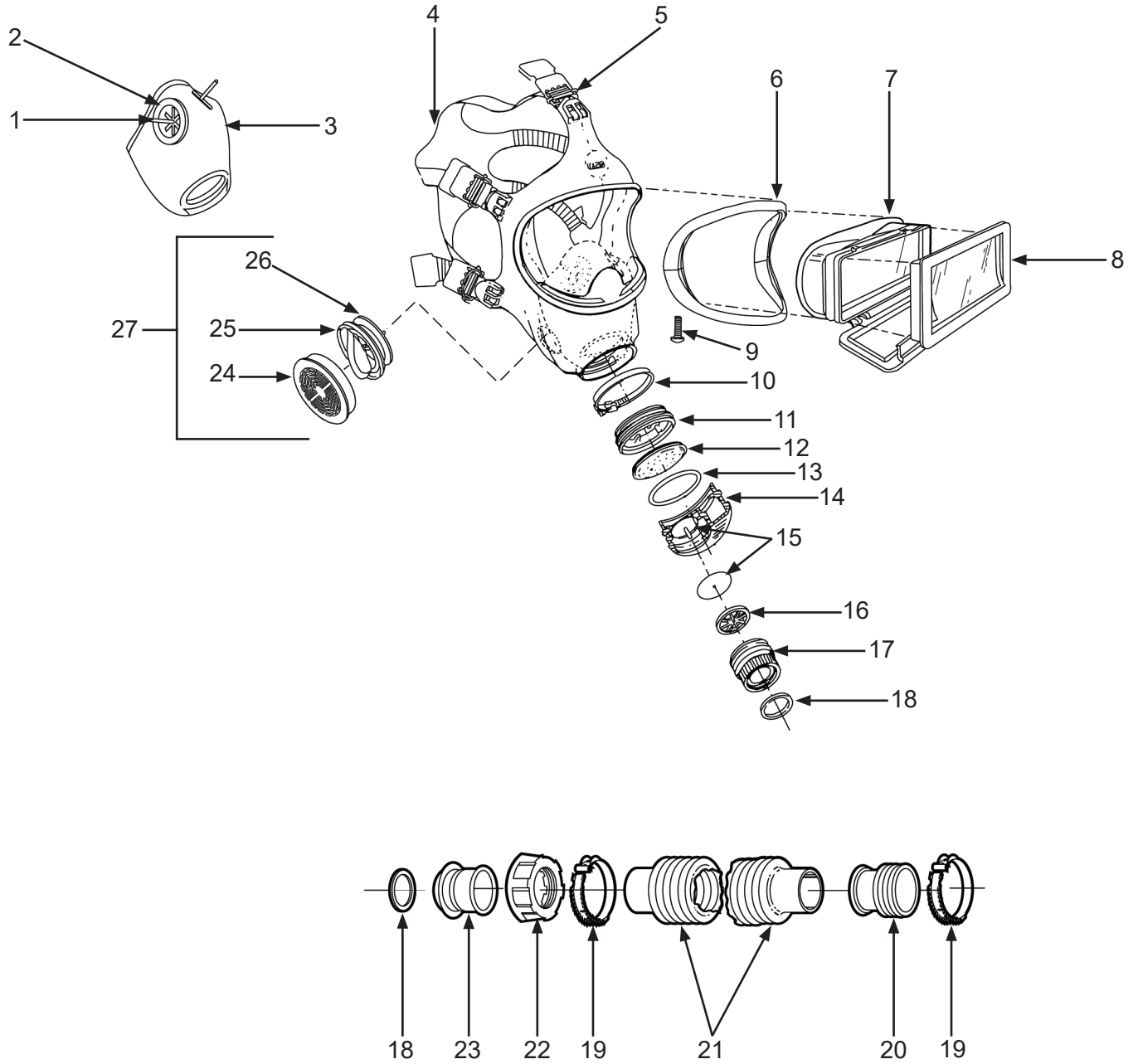



## OPTIONAL ACCESSORIES



### Part Numbers

MSA V-GARD® SERIES HARD HATS						
Series	Style	Fas-Trac® Ratchet Suspension	Staz-On® Pinlock Suspension	Color	Minimum Order Quantity	
30MSA475368	V-Gard®	Cap Style	X	Blue	One Each	
10MSA475364	V-Gard®	Cap Style	X	Gray	One Each	
10MSA475361	V-Gard®	Cap Style	X	Orange	One Each	
30MSA463948	V-Gard®	Cap Style		Gray	One Each	
30MSA463945	V-Gard®	Cap Style		Orange	One Each	
30MSA463942	V-Gard®	Cap Style		White	One Each	

### Part Numbers

MSA V-GARD® SERIES HARD HAT ACCESSORIES	
Part Numbers	Description
 10MSA10087220	Fas-Trac®, 4-Point Ratchet Suspension
 10MSA10087218	Staz-On®, 4-Point Pinlock Suspension
 10MSA10061123	1-Touch® Slide, 4-Point Suspension

## BREATHING LINE

Part Numbers	MSA BREATHING LINE			
	Compressed Air	Breathing Line I.D.	Length	Hose Material
10MSA481071	X	3/8"	8 Feet	Neoprene
10MSA455020	X	3/8"	15 Feet	Neoprene
10MSA455021	X	3/8"	25 Feet	Neoprene
10MSA455022	X	3/8"	50 Feet	Neoprene
10MSA481051	X	3/8"	8 Feet	PVC
10MSA471511	X	3/8"	15 Feet	PVC
10MSA471512	X	3/8"	25 Feet	PVC
10MSA471513	X	3/8"	50 Feet	PVC
10MSA484225	X	3/8"	100 Feet	PVC
10MSA491513	X	3/8"	8 Feet	Coiled Nylon
10MSA491514	X	3/8"	15 Feet	Coiled Nylon
10MSA491515	X	3/8"	25 Feet	Coiled Nylon
10MSA474043	X	3/8"	50 Feet	Coiled Nylon



10MSA455020  
10MSA455021  
10MSA455022  
10MSA455022



10MSA451051  
10MSA471511  
10MSA471513  
10MSA484225

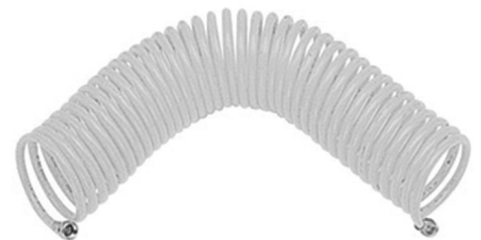

10MSA491513  
10MSA491514  
10MSA491515  
10MSA474043

## QUICK-DISCONNECT COUPLINGS

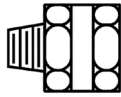
	Part Numbers	AIR SUPPLY HOSE CONNECTOR	
		Description	
	10MSA69541	1/4" NPT Air Supply Hose Connector <i>For use with all style Sockets</i>	

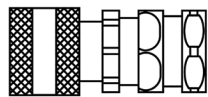
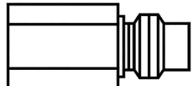
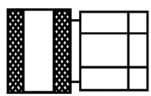
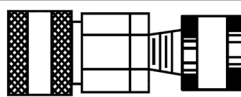
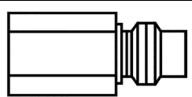
	Part Numbers	SNAP-TITE® FITTINGS		
		Type	Style	Material
	10MSA479032	Locking	Socket	Aluminum
	10MSA479027	Locking	Plug for Quick-Disconnect	Aluminum
	10MSA66272	Non-Locking	Socket	Aluminum
	10MSA630305	Non-Locking	Socket	Brass
	10MSA629673	Non-Locking	Socket	Stainless Steel
	10MSA455019	Non-Locking	Socket Assembly	Aluminum
	10MSA471777	Non-Locking	Socket Assembly	Brass
	10MSA471778	Non-Locking	Socket Assembly	Stainless Steel
	10MSA66274	Non-Locking	Plug for Quick-Disconnect	Aluminum
	10MSA630307	Non-Locking	Plug for Quick-Disconnect	Brass
	10MSA629672	Non-Locking	Plug for Quick-Disconnect	Stainless Steel

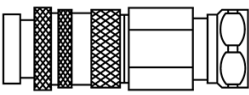
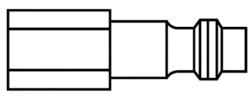

	Part Numbers	CEJN FITTINGS		
		Type	Style	Material
	10MSA476956	Locking	Socket	Chrome
	10MSA479026	Locking	Plug for Quick-Disconnect	Chrome

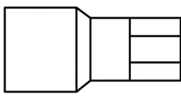
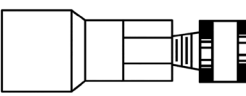
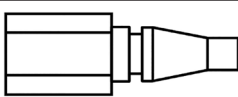
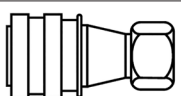
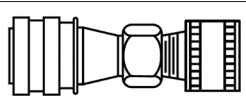
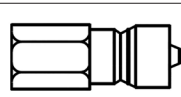
## QUICK-DISCONNECT COUPLINGS

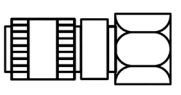
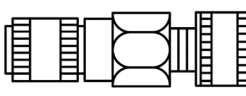
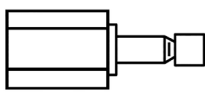
	Part Numbers	FOSTER® FITTINGS		
		Type	Style	Material
	10MSA628770	Non-Locking	Socket	Steel
	10MSA636459	Non-Locking	Socket	Stainless Steel
	10MSA467044	Non-Locking	Socket Assembly	Steel
	10MSA801016	Non-Locking	Socket Assembly	Stainless Steel
	10MSA55716	Non-Locking	Plug for Quick-Disconnect	Steel
	10MSA636460	Non-Locking	Plug for Quick-Disconnect	Stainless Steel
	10MSA629980	Non-Locking with Check Valve	Socket	Brass
	10MSA470194	Non-Locking with Check Valve	Socket Assembly	Brass
	10MSA629981	Non-Locking with Check Valve	Plug for Quick-Disconnect	Brass

	Part Numbers	DUFF-NORTON® FITTINGS		
		Type	Style	Material
	10MSA630308	Non-Locking	Socket	Brass
	10MSA471780	Non-Locking	Socket Assembly	Brass
	10MSA630309	Non-Locking	Plug for Quick-Disconnect	Brass

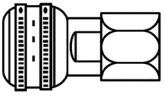
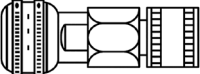
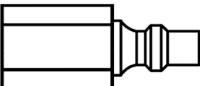
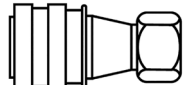
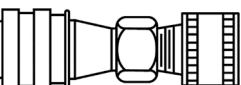
## QUICK-DISCONNECT COUPLINGS

	Part Numbers	HANSEN FITTINGS		
		Type	Style	Material
	10MSA630311	Non-Locking	Socket	Brass
	10MSA471501	Non-Locking	Socket Assembly	Brass
	10MSA630313	Non-Locking	Plug for Quick-Disconnect	Brass
	10MSA628768	Non-Locking with Check Valve	Socket	Stainless Steel
	10MSA471779	Non-Locking with Check Valve	Socket Assembly	Stainless Steel
	10MSA628208	Non-Locking with Check Valve	Plug for Quick-Disconnect	Stainless Steel





## ALLREDI THERE

Serving these industries: Bridge, Pipeline, Tank & Tower, Concrete Services, Rail, Shipyard & Marine, Pools & Fountains and Foundry

### UNITED STATES

**Pasadena, TX** (*Headquarters*)

844.361.7038

**Beaumont, TX**

409.722.1284

**Bristol, PA**

215.826.8080

**Corpus Christi, TX**

361.887.2038

**Davenport, IA**

563.324.2519

**Deer Park, TX**

(*Service & Rental Location*)

281.930.0905

**Duluth, GA**

800.535.4564

**Gonzales, LA**

225.647.7575

**Harvey, LA**

504.367.8090

**Houma, LA**

985.580.4273

**Jacksonville, FL**

904.262.2120

**Lafayette, LA**

337.267.1440

**Theodore, AL**

251.338.7525

**Youngstown, OH**

330.448.6267

### CANADA

**Calgary, Alberta**

403.279.1924

**Coquitlam, BC**

604.464.6979

**Edmonton, Alberta**

780.468.2588 (Manus)

780.425.5510 (Mod-U-Blast)

**Hamilton, Ontario**

905.527.6000 / 888.794.5665

**Mississauga, Ontario**

905.890.5837

**Winnipeg, Manitoba**

204.256.3324

**800-252-7848 / WWW.ALLREDI-US.COM**

Allredi™ and Marco® are registered trademarks of Allredi, LLC.  
All other brand names or marks are used for identification purposes and are trademarks of their respective owners.



Literature #106M441\_2/16/2022