



EMPIRE SAF-STOP II REMOTE CONTROL SWITCHES



PART NUMBERS AND SCHEMATIC GUIDE

Company Profile

Allredi was formed in the early 2020, when two of the largest distributors in the blasting, coating, safety, and environmental industry, APE Companies and Marco Group International, joined forces. While the qualities both companies are known for have not changed, a lot about our business is new. New abilities. New agilities. New ways to help you win. This calls for a new name, Allredi.

This name exemplifies what we have become. It is completely oriented to the needs of our customers. To your needs. It says that when you call us for anything – products, service, expert advice, anything – you can consider it done. Or even better, Allredi done.

We are your right-now supplier. From skills to SKUs, we deliver the goods fast. So you can be more agile every minute, every day. This is who we are. This is what our new name means. Go ahead and expect excellence, because we're bringing it.

Our Mission and Vision

To be the industry's preferred partner in surface preparation solutions through unrivaled technical expertise, customer experience, product availability, and tailored service offerings.

The Allredi Difference

- **Industry Experience** – With Allredi on your team, you have access to expertise which can only come from decades of industry leadership. We have organized our engineering department, production specialists, customer operations, and safety support into a "Center of Competence." As an Allredi customer, you have access to hundreds of years of cumulative experience related to your operations.
- **Manufacturing Excellence** – Allredi is a U.S. based manufacturer of equipment for the Surface Preparation and Protective Coatings industries. Allredi's engineers benchmark the industry to ensure that we design and manufacture superior products that set the "Gold Standard" for performance, safety, and quality.
- **Legendary Customer Service** – Allredi's legendary customer service team is staffed by friendly, highly-trained individuals who are focused on providing the highest level of product support, order accuracy, and customer satisfaction.
- **Product Availability** – We stock over 10,000 SKU's and have over 45 shipping locations to serve North American and International markets for all major brands of blasting, coating, environmental, and safety equipment. Allredi is your right-now supplier, so you can keep your projects moving. From our foundation of strong relationships, we have built a nationwide network that puts vast inventory and ready service close to our customers. We provide advanced expertise, and we deliver the goods fast – so you can easily access the products and services you need to me more agile every minute, every day.
- **Technology Leadership** – Our website provides: Operator's Manuals, Part Numbers and Schematics Guides, SDS information, and key product features and specifications, providing access to information 24/7.

DEFINITION OF TERMS

Company Profile	1
Table of Contents	2
Empire Saf-Stop II	
Remote Control Switches	3-10
Part Numbers	3-4
Empire Saf-Stop II Pneumatic Remote Control Switch Part Numbers & Schematics	5-6
Optional Accessories	7-8
Empire Saf-Stop II Electric Remote Control Switch Part Numbers & Schematics	9
Optional Accessories	10

PART NUMBERS

EMPIRE SAF-STOP II PNEUMATIC REMOTE CONTROL SWITCHES

Part Numbers	Body Material	Repairable	Pneumatic Control Line Fittings
10EM290164	Aluminum	Yes	1/4" & 1/8" NPT

EMPIRE SAF-STOP II ELECTRIC REMOTE CONTROL SWITCH

Part Numbers	Body Material	Replaceable Switch	Electric Control Line Length	Plug
10EM290354	Aluminum	Yes	3 Feet	2-Prong Male

EMPIRE SAF-STOP II REMOTE CONTROL SWITCHES

Figure 1a: Empire Saf-Stop II Pneumatic Remote Control Switch

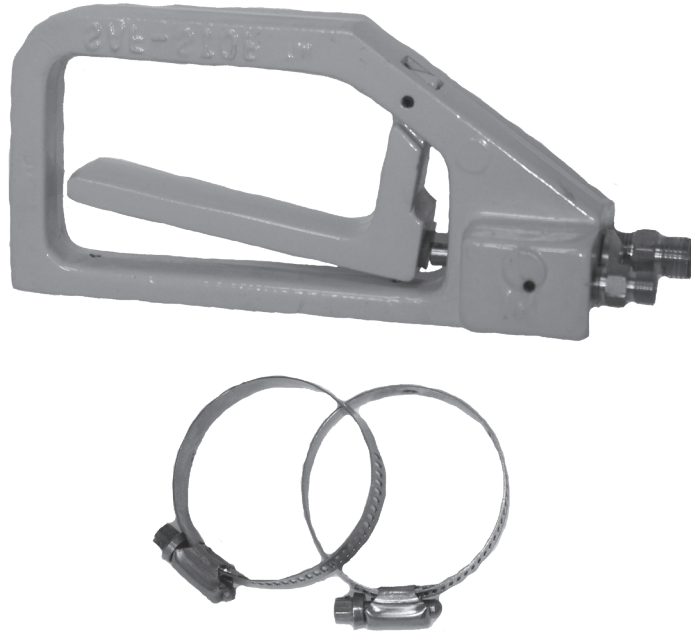
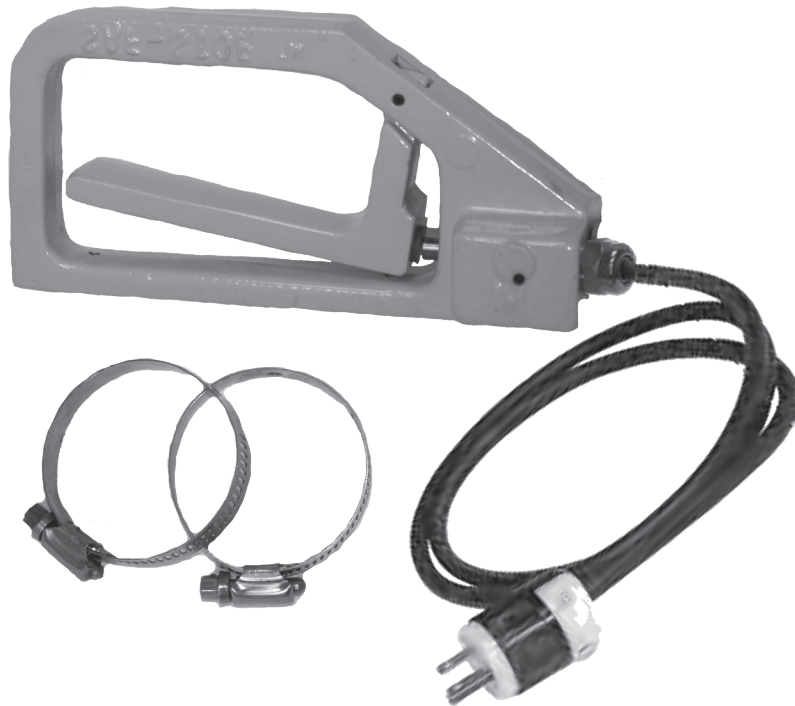

Figure 2: Empire Saf-Stop II Electric Remote Control Switch



PART NUMBERS & SCHEMATICS

Item #	Part #	Description
Fig. 3		
—	10EM290164	Empire Saf-Stop II Pneumatic Remote Control Switch – Complete
1	10EM520222	1/4" x 1/4" Hose Adapter
2	10EM525112	Urethane Disc
3	10EM520521	3" Adjustable Clamp (<i>Two Required</i>)
4	10EM290224	Empire Saf-Stop II Plunger Kit <i>Includes: Push Rod, Nut, Spring, Washer, O-ring</i>
5	10EM290225	Empire Saf-Stop II Parts Kit <i>Includes: Washer, O-ring (Quantity of Two), Urethane Disc</i>
6	10EM520122	Empire Saf-Stop II Brass Plug
7	10EM520212	1/8" x 1/8" Hose Adapter
—	106M459	Part Numbers and Schematics Guide – Empire Saf-Stop II Remote Control Switch



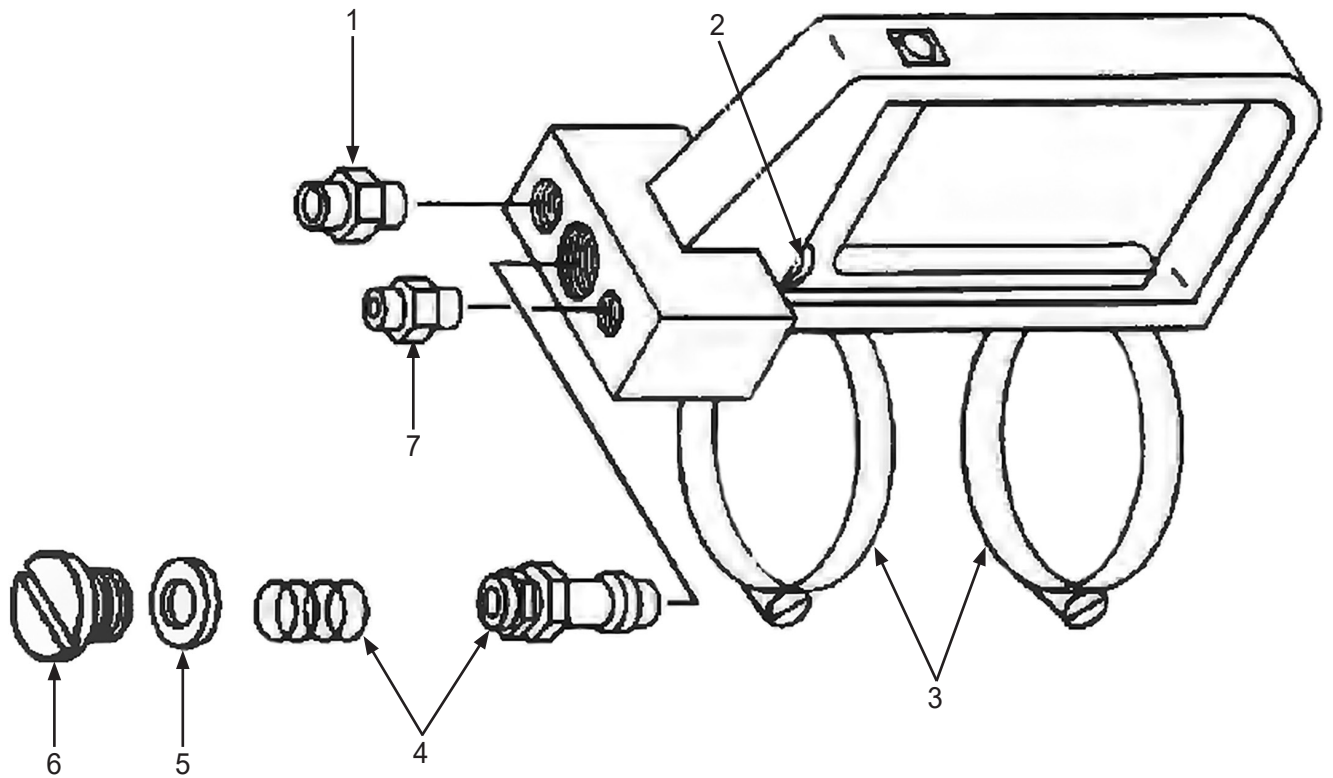

PART NUMBERS & SCHEMATICS

Figure 3: Empire Saf-Stop II Pneumatic Remote Control Switch











OPTIONAL ACCESSORIES

PNEUMATIC CONTROL LINE

	Part Numbers	Hose Length	Working Pressure	Hose I.D.	Hose O.D.	1017012 <i>Quantity of Two</i>	1017013 <i>Quantity of Two</i>
	10TL10PG	10 Feet	200 psi	3/16"	7/16"	X	X
	10TL50PG	50 Feet	200 psi	3/16"	7/16"	X	X
	10TL100PG	100 Feet	200 psi	3/16"	7/16"	X	X
	10TLBK	Per Foot	200 psi	3/16"	7/16"		

OPTIONAL ACCESSORIES

		PNEUMATIC CONTROL LINE FITTINGS		
	Part Numbers	Description	Hose I.D.	Hose O.D.
	1017012	1/8" Female Nut & Barb	3/16"	7/16"
	1017013	1/4" Female Nut & Barb	3/16"	7/16"
	1017010	Hose Splicer	3/16"	7/16"
	1017017	Hose Ferrule	3/16"	7/16"
	1017011	Oetiker® Clamp	3/16"	7/16"
	1017026	1/8" x 1/8" Hose Union	3/16"	7/16"
	1017027	1/4" x 1/4" Hose Union	3/16"	7/16"

	Part Numbers	PNEUMATIC CONTROL LINE FITTINGS ACCESSORIES		
	10DX855A	Ferrule Crimping Tool		
	10DX1098	Oetiker® Clamp Tool		

Oetiker® is a registered trademark of Dixon Valve & Coupling Co.

PART NUMBERS & SCHEMATICS

Figure 4: Empire Saf-Stop II Electric Remote Control Switch

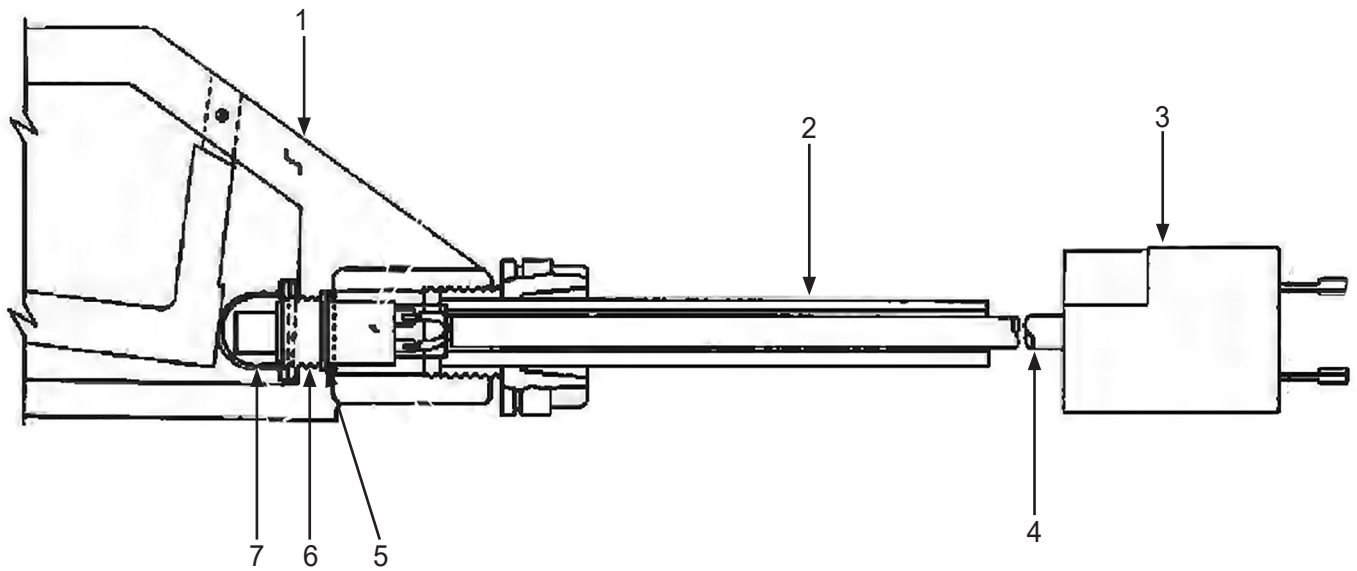





Item #	Part #	Description
--------	--------	-------------

Fig. 4

—	10EM290354	Empire Saf-Stop II Electric Remote Control Switch with 3' Electric Cord and Plug – Complete
1	10EM753672	Handle with Trigger
2	10EM290353	Electric Saf-Stop Cord with Fittings
3	1015551	Male 2-Prong Twist-Lock Male Plug
4	—	Electric Cord (<i>See Optional Accessories</i>)
5	10EM523972	O-ring
6	10EM534531	Push Button
7	10EM534541	Push Button Foot
—	106M459	Part Numbers and Schematics Guide – Empire Saf-Stop II Remote Control Switches

OPTIONAL ACCESSORIES

		ELECTRIC CONTROL LINE WITH PLUGS						
	Part Numbers	Gauge	# of Wires	2-Prong Male Twist-Lock Plug	2-Prong Female Twist-Lock Plug	3-Prong Male Twist-Lock Plug	3-Prong Female Twist-Lock Plug	Length
	1015543	16	2	1015551	1015552	—	—	25 Feet
	1015542	16	2	1015551	1015552	—	—	50 Feet

		ELECTRIC CONTROL LINE PLUGS	
	Part Numbers	Prong Style	Plug Style
	1015551	2-Prong Male	Twist-Lock
	1015552	2-Prong Female	Twist-Lock

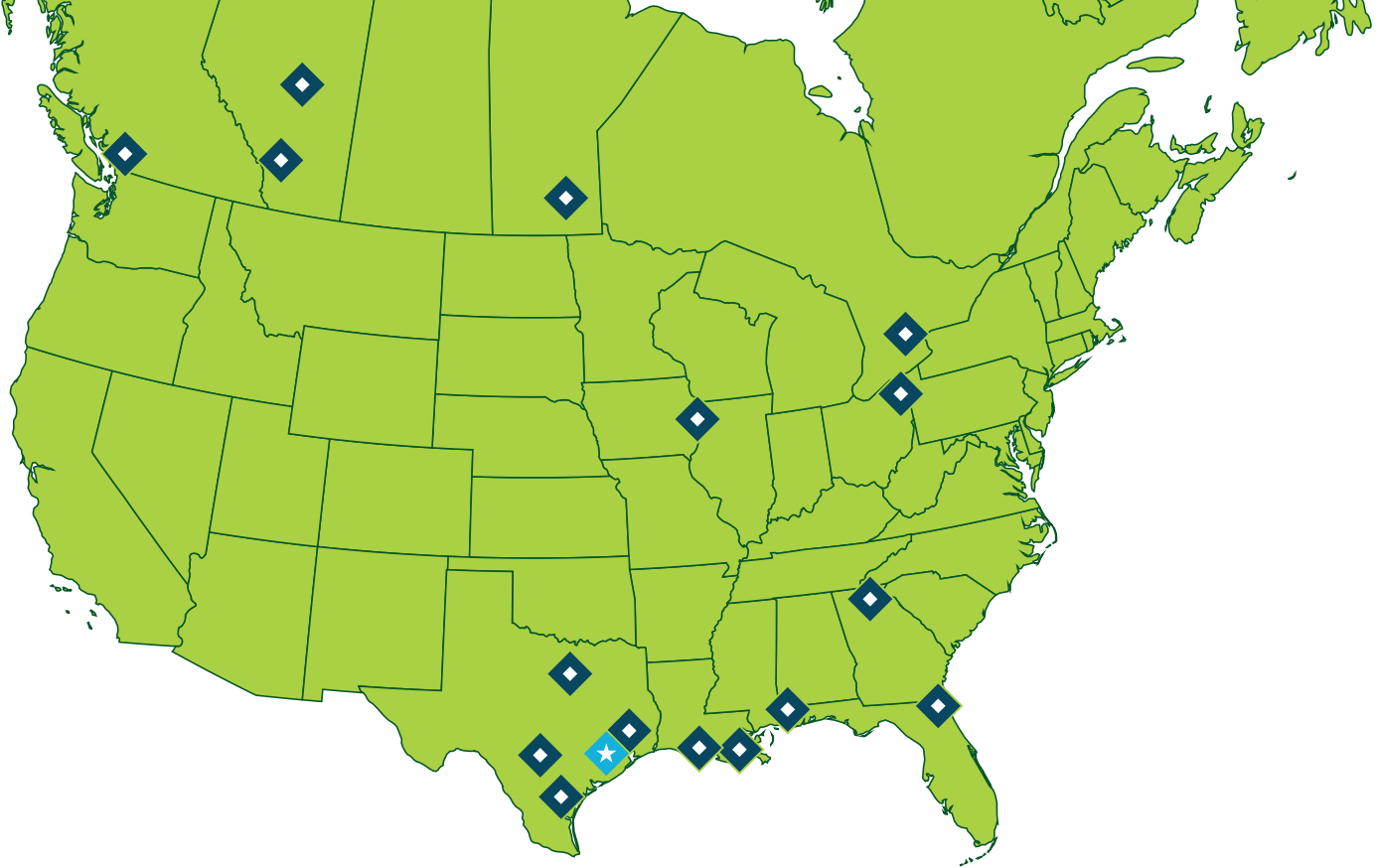

ALLREDI THERE

Serving these industries: Bridge, Pipeline, Tank & Tower, Concrete Services, Rail, Shipyard & Marine, Pools & Fountains and Foundry

UNITED STATES

Pasadena, TX (Headquarters)

844.361.7038

Beaumont, TX

409.722.1284

Bristol, PA

215.826.8080

Corpus Christi, TX

361.887.2038

Davenport, IA

563.324.2519

Deer Park, TX

(Service & Rental Location)

281.930.0905

Duluth, GA

800.535.4564

Gonzales, LA

225.647.7575

Harvey, LA

504.367.8090

Houma, LA

985.580.4273

Jacksonville, FL

904.262.2120

Lafayette, LA

337.267.1440

Theodore, AL

251.338.7525

Youngstown, OH

330.448.6267

CANADA

Calgary, Alberta

403.279.1924

Coquitlam, BC

604.464.6979

Edmonton, Alberta

780.468.2588 (Manus)

780.425.5510 (Mod-U-Blast)

Hamilton, Ontario

905.527.6000 / 888.794.5665

Mississauga, Ontario

905.890.5837

Winnipeg, Manitoba

204.256.3324

800-252-7848 / WWW.ALLREDI-US.COM

Allredi™ and Marco® are registered trademarks of Allredi, LLC.

All other brand names or marks are used for identification purposes and are trademarks of their respective owners.

ALLREDI™

Literature #106M459_8/23/22