



# BULLARD® 41 SERIES AIRLINE FILTERS



PART NUMBERS AND SCHEMATIC GUIDE

## Company Profile

Allredi was formed in the early 2020, when two of the largest distributors in the blasting, coating, safety, and environmental industry, APE Companies and Marco Group International, joined forces. While the qualities both companies are known for have not changed, a lot about our business is new. New abilities. New agilities. New ways to help you win. This calls for a new name, Allredi.

This name exemplifies what we have become. It is completely oriented to the needs of our customers. To your needs. It says that when you call us for anything – products, service, expert advice, anything – you can consider it done. Or even better, Allredi done.

We are your right-now supplier. From skills to SKUs, we deliver the goods fast. So you can be more agile every minute, every day. This is who we are. This is what our new name means. Go ahead and expect excellence, because we're bringing it.

## Our Mission and Vision

To be the industry's preferred partner in surface preparation solutions through unrivaled technical expertise, customer experience, product availability, and tailored service offerings.

## The Allredi Difference

- **Industry Experience** – With Allredi on your team, you have access to expertise which can only come from decades of industry leadership. We have organized our engineering department, production specialists, customer operations, and safety support into a "Center of Competence." As an Allredi customer, you have access to hundreds of years of cumulative experience related to your operations.
- **Manufacturing Excellence** – Allredi is a U.S. based manufacturer of equipment for the Surface Preparation and Protective Coatings industries. Allredi's engineers benchmark the industry to ensure that we design and manufacture superior products that set the "Gold Standard" for performance, safety, and quality.
- **Legendary Customer Service** – Allredi's legendary customer service team is staffed by friendly, highly-trained individuals who are focused on providing the highest level of product support, order accuracy, and customer satisfaction.
- **Product Availability** – We stock over 10,000 SKU's and have over 45 shipping locations to serve North American and International markets for all major brands of blasting, coating, environmental, and safety equipment. Allredi is your right-now supplier, so you can keep your projects moving. From our foundation of strong relationships, we have built a nationwide network that puts vast inventory and ready service close to our customers. We provide advanced expertise, and we deliver the goods fast – so you can easily access the products and services you need to me more agile every minute, every day.
- **Technology Leadership** – Our website provides: Operator's Manuals, Part Numbers and Schematics Guides, SDS information, and key product features and specifications, providing access to information 24/7.

# TABLE OF CONTENTS

<b>Company Profile</b> .....	<b>2</b>
<b>Table of Contents</b> .....	<b>3</b>
<b>Bullard® 41 Series Airline Filters</b> .....	<b>4-13</b>
Part Numbers .....	4-5
Part Numbers & Schematics .....	6-10
2-Outlet .....	6-7
6-Outlet .....	8-9
Single Outlet .....	10
Optional Accessories .....	11-13
<b>Maintenance Notes</b> .....	<b>14-15</b>

# PART NUMBERS

<b>BULLARD® 41 SERIES AIRLINE FILTERS</b>		
<b>Part Numbers</b>	<b>Style</b>	<b>Number of Outlets</b>
10B41P2	Stationary	2-Outlet
10B41P6	Stationary	6-Outlet
10B41A	Stationary	1-Outlet
10B41P2WM	Wall Mount	2-Outlet
10B41P6WM	Wall Mount	6-Outlet

# BULLARD® 41 SERIES AIRLINE FILTERS



10B41P2



10B41P6



10B41A



10B41P2WM



10B41P6WM

## PART NUMBERS & SCHEMATICS GUIDE

### Bullard® 41P2 Airline Filter

Item #	Part #	Description
<b>Fig. 1</b>		
—	<b>10B41P2</b>	<b>Bullard® 41P2 Airline Filter – 2-Outlet</b>
—	<b>10B41P2WM</b>	<b>Bullard® 41P2 Airline Filter – 2-Outlet – Wall Mount</b> <i>Wall Mount Bracket not available separately</i>
1	10B41P2R	Regulator and Assembly <i>Includes Item #2</i>
2	10B41KB2	Regulator Knob
3	1028607	Pressure Relief Valve – 1/4" NPT – 125 psi
4	1028633 10B41AF	Marco Filter Cartridge ( <i>Alternative</i> ) Filter Cartridge
5	10B41DRAIN	Drain
6	1028619	3/8-16 Nut ( <i>Eight Required</i> )
7	10101936	3/8" Lock Washer ( <i>Eight Required</i> )
8	10B41ATOPYLW	Lid
9	1014241	3/8" Flat Washer ( <i>Eight Required</i> )
10	10102252	3/8-16 x 2" Zinc Hex Head Cap Screw ( <i>Eight Required</i> )
—	10B41P2M	2-Outlet Manifold Assembly <i>Includes Item #'s: 1, 2, 3, and 5</i>
—	10B41HK	Handle Kit ( <i>not shown</i> )
—	105V483	Features and Specifications Guide – Bullard 41 Series Airline Filters
—	106M483	Part Numbers & Schematics Guide – Bullard 41 Series Airline Filters
—	109V483	Operator's Manual – Bullard 41 Series Airline Filters

# PART NUMBERS & SCHEMATICS GUIDE

Figure 1: Bullard® 41P2 Airline Filter

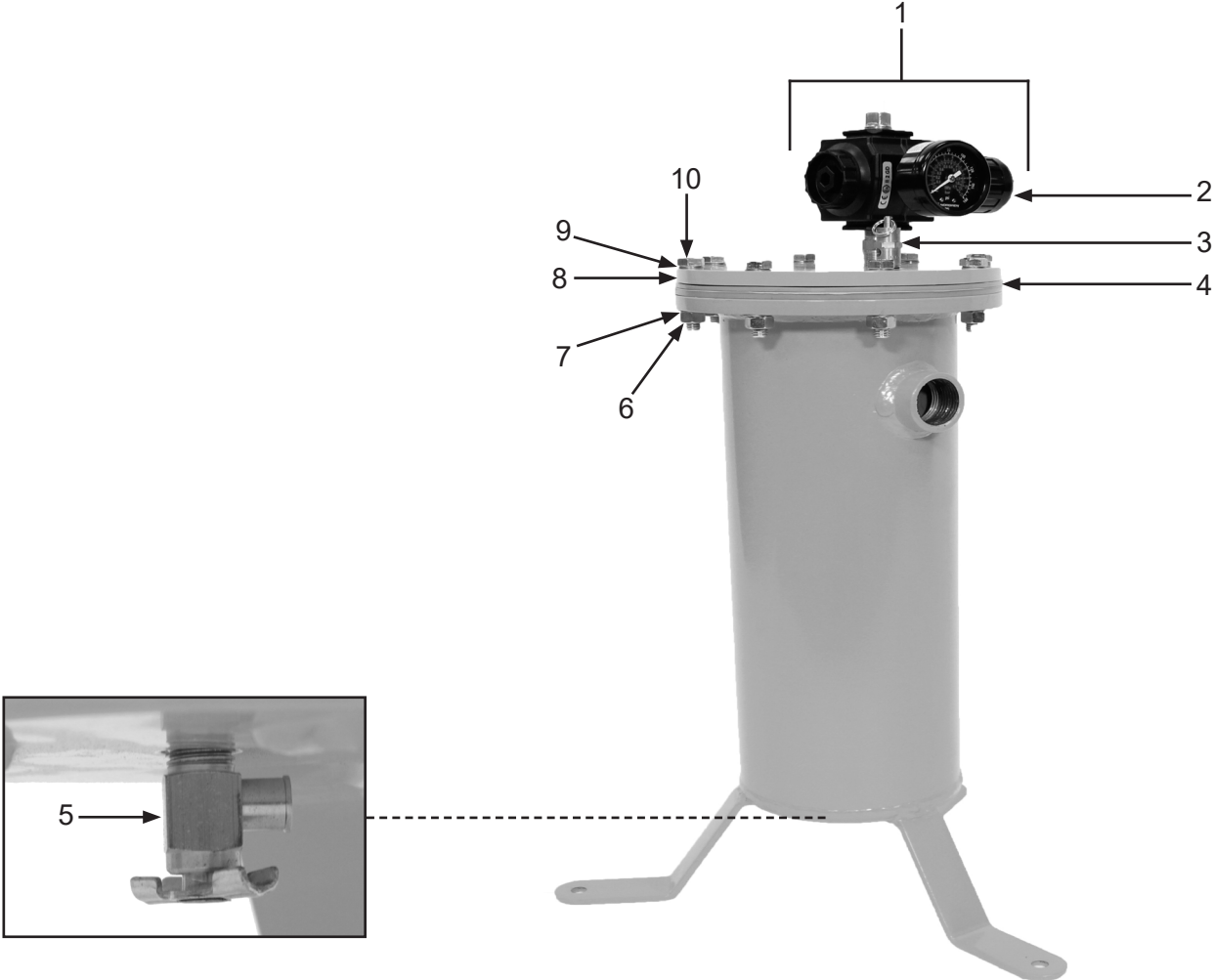

## PART NUMBERS & SCHEMATICS GUIDE

### Bullard® 41P6 Airline Filter

Item #	Part #	Description
<b>Fig. 2</b>		
—	<b>10B41P6</b>	<b>Bullard® 41P6 Airline Filter – 6-Outlet</b>
—	<b>10B41P6WM</b>	<b>Bullard® 41P6 Airline Filter – 2-Outlet – Wall Mount</b> <i>Wall Mount Bracket not available separately</i>
1	10B41RG	Outlet Air Pressure Gauge
2	10B41P6UPK	6-Outlet Manifold Upgrade <i>Includes Item #1, Bell Reducer, and Regulator Assembly</i>
3	1011213	3/4" Close Nipple
4	1028607	Pressure Relief Valve – 1/4" NPT – 125 psi
5	10B41DRAIN	Drain
6	1011505	1" x 3/4" Bushing
7	1028619	3/8-16 Nut <i>(Eight Required)</i>
8	10101936	3/8" Lock Washer <i>(Eight Required)</i>
9	1028633 10B41AF	Marco Filter Cartridge <i>(Alternative)</i> Filter Cartridge
10	1014241	3/8" Flat Washer <i>(Eight Required)</i>
11	10102252	3/8-16 x 2" Zinc Hex Head Cap Screw <i>(Eight Required)</i>
12	1028615	3/8" NPT Pipe Plug
—	10B41HK	Handle Kit <i>(not shown)</i>
—	105V483	Features and Specifications Guide – Bullard 41 Series Airline Filters
—	106M483	Part Numbers & Schematics Guide – Bullard 41 Series Airline Filters
—	109V483	Operator's Manual – Bullard 41 Series Airline Filters



# PART NUMBERS & SCHEMATICS GUIDE

Figure 2: Bullard® 41P6 Airline Filter

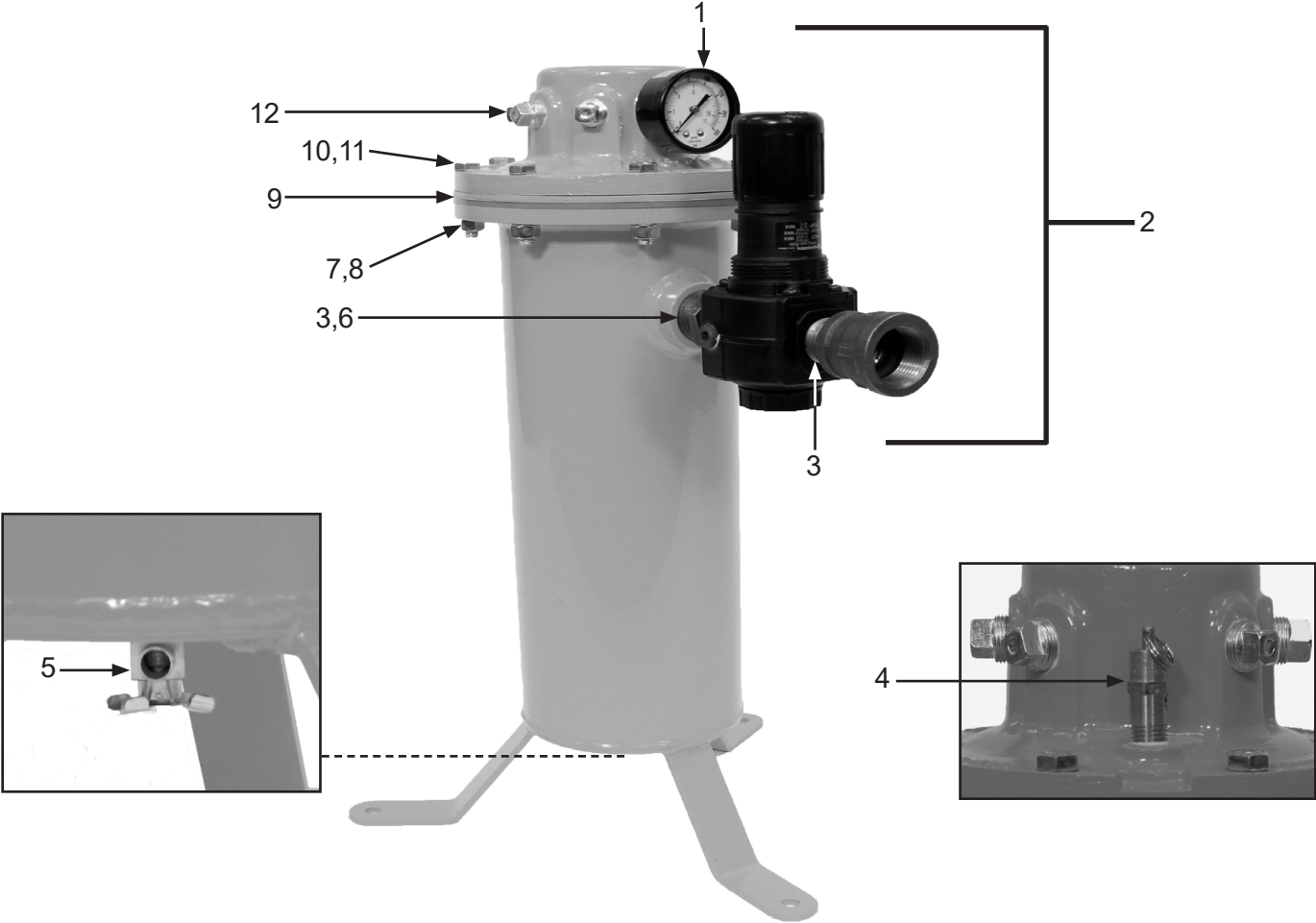





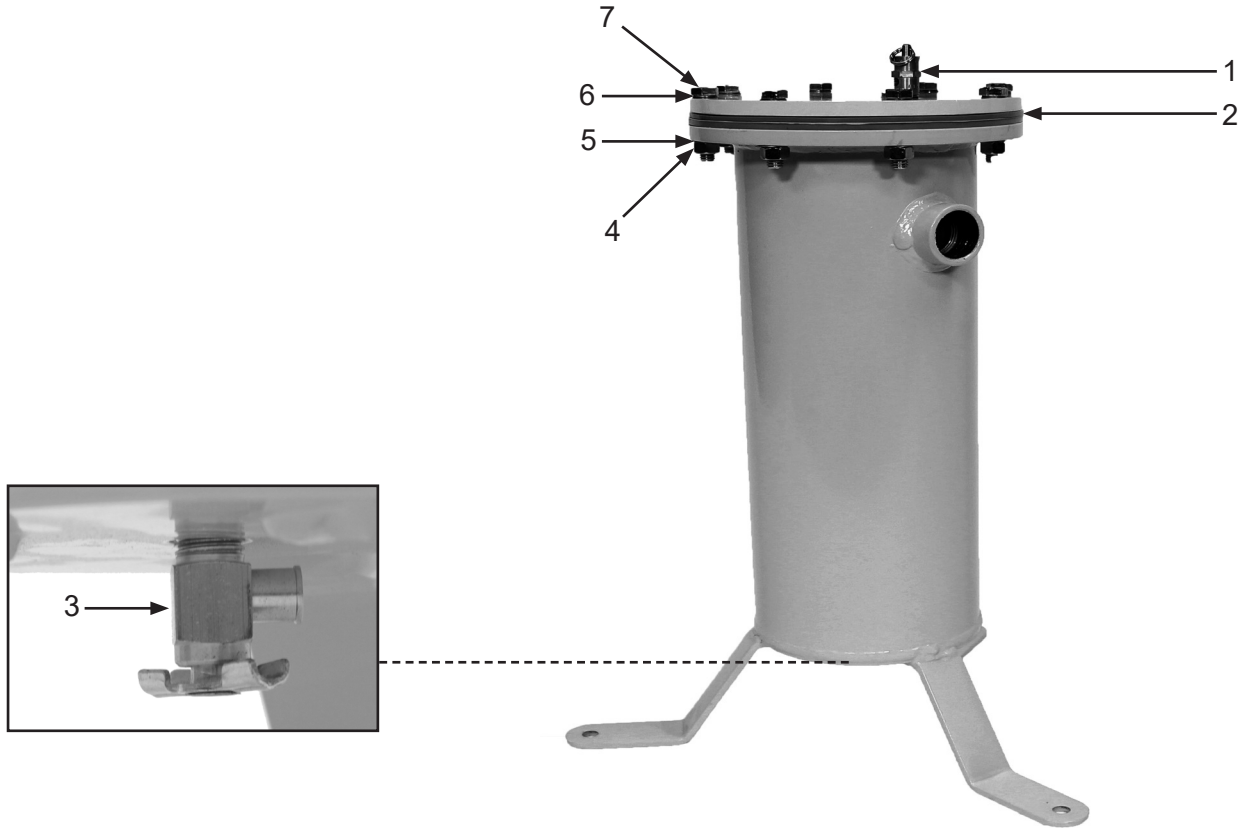



## PART NUMBERS & SCHEMATICS

**Figure 3: Bullard® 41A Airline Filter**



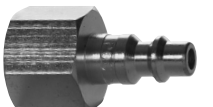

Item #	Part #	Description
<b>Fig. 3</b>		
—	<b>10B41A</b>	<b>Bullard® 41A Airline Filter – 1-Outlet</b>
1	1028607	Pressure Relief Valve – 1/4" NPT – 125 psi
2	1028633 10B41AF	Marco Filter Cartridge ( <i>Alternative</i> ) Filter Cartridge
3	1028607	Pressure Relief Valve – 1/4" NPT – 125 psi
4	1028619	3/8-16 Nut ( <i>Eight Required</i> )
5	10101936	3/8" Lock Washer ( <i>Eight Required</i> )
6	1014241	3/8" Flat Washer ( <i>Eight Required</i> )
7	10102252	3/8-16 x 2" Zinc Hex Head Cap Screw ( <i>Eight Required</i> )
—	105V483	Features and Specifications Guide – Bullard 41 Series Airline Filters
—	106M483	Part Numbers & Schematics Guide – Bullard 41 Series Airline Filters
—	109V483	Operator's Manual – Bullard 41 Series Airline Filters

## OPTIONAL ACCESSORIES

		<b>BREATHING LINE FITTINGS AND QUICK-DISCONNECT COUPLINGS</b>
<b>Part Numbers</b>	<b>Description</b>	
	<b>10BV11</b>	3/8" Male x 3/8" Male Hose to Hose Connector Hex Nipple <i>Replace 10BV11 with 10BV27 if not using 10B4696 Starter Hose</i>
	<b>10BV12</b>	3/8" Male NPT Pipe Thread to 1/4" Male Hose Adapter Hex Nipple <i>Included in 10BV27</i>
	<b>10BV13</b>	3/8" Male NPT Pipe Thread to 3/8" Male Hose Adapter Hex Nipple <i>Comes on 10B5454, 10B5457 and 10B5458</i>
	<b>10BV14</b>	1/4" Female Quick-Disconnect Coupling, Shut-Off with 1/4" Female Pipe Thread <i>Included in 10BV27</i>
	<b>10BV19</b>	1/4" Female Snap-Tite Quick-Disconnect Coupling, Shut-off with 1/4" Female Pipe Thread
	<b>10BV15</b>	1/4" Female Quick-Disconnect Coupling, Shut-Off with 3/8" Male Pipe Thread <i>Install on airline filter to make quick-disconnect</i>
	<b>10BV27</b>	1/4" Female Industrial Interchange Coupling Assembly <i>Includes 10BV12 and 10BV14</i> <i>Replaces 10BV13 at the hood to make quick-disconnect if not using 10B4696 Starter Hose</i>
	<b>10BV17</b>	1/4" Male Industrial Interchange Quick-Disconnect Coupling, 3/8" Female NPT Pipe Thread <i>Add to 10BV13 to make quick-disconnect at airline filter</i>
	<b>10BS19442</b>	1/4" Male Snap-Tite Quick-Disconnect Coupling With 1/4" Female NPT Pipe Thread
	<b>10BS19432</b>	1/4" Male Schrader® Coupling with 1/4" Male Pipe Thread

## OPTIONAL ACCESSORIES

		<b>3/4" I.D. X 1-1/4" O.D. AIR HOSE</b>				
	<b>Part Numbers</b>	<b>Length</b>	<b>Hose I.D.</b>	<b>Hose O.D.</b>	<b>Working Pressure</b>	<b>Hose Cover Color</b>
	10AH034	Per Ft.	3/4"	1-1/4"	200 PSI	Red

		<b>3/4" I.D. X 1-1/4" O.D. AIR HOSE WITH COUPLINGS INSTALLED</b>					
	<b>Part Numbers</b>	<b>Length</b>	<b>Hose I.D.</b>	<b>Hose O.D.</b>	<b>Working Pressure</b>	<b>Hose Cover Color</b>	<b>Couplings</b>
	10AH034AC	50 Ft.	3/4"	1-1/4"	200 PSI	Red	2-Lug Crimped On

		<b>MALE HOSE END COUPLING AND GASKET FOR 3/4" I.D. AIR HOSE</b>					
	<b>Part Numbers</b>	<b>Hose I.D.</b>	<b>Material</b>	<b>Coupling Style</b>	<b>GASKET</b>		
					<b>Rubber Gasket</b>	<b>Gasket I.D.</b>	<b>Gasket O.D.</b>
	10HE1	3/4"	Zinc-Plated Iron	2-Lug	10UG2	3/4"	1-3/8"

		<b>BOSS CLAMP FOR 3/4" I.D. AIR HOSE</b>		
	<b>Part Numbers</b>	<b>Hose I.D.</b>	<b>Hose O.D. Range</b>	<b>Material</b>
	10A9	3/4"	1-1/8"–1-5/16"	Plated Steel

## OPTIONAL ACCESSORIES

		1" I.D. X 1-1/2" O.D. AIR HOSE				
	<b>Part Numbers</b>	Length	Hose I.D.	Hose O.D.	Working Pressure	Hose Cover Color
	10AH100	Per Ft.	1"	1-1/2"	200 PSI	Red

		1" I.D. X 1-1/2" O.D. AIR HOSE WITH COUPLINGS INSTALLED						
	<b>Part Numbers</b>	Length	Hose I.D.	Hose O.D.	Working Pressure	Hose Cover Color	Couplings	Band Clamps
	10AH100AC	50 Ft.	1"	1-1/2"	200 PSI	Red	2-Lug Crimped On	

		MALE HOSE END COUPLING AND GASKET FOR 1" I.D. AIR HOSE					
	<b>Part Numbers</b>	Hose I.D.	Material	Coupling Style	GASKET		
					Rubber Gasket	Gasket I.D.	Gasket O.D.
	10HE2	1"	Plated Iron	2-Lug	10UG2	3/4"	1-3/8"

		HAMMER-LOCK FITTING FOR 1" I.D. AIR HOSE	
	<b>Part Numbers</b>	Hose I.D.	Material
	10DXGF36	1"	Plated Steel

		BOSS CLAMP FOR 1" I.D. AIR HOSE		
	<b>Part Numbers</b>	Hose I.D.	Hose O.D. Range	Material
	10A14	1"	1-1/2"–1-13/16"	Plated Steel





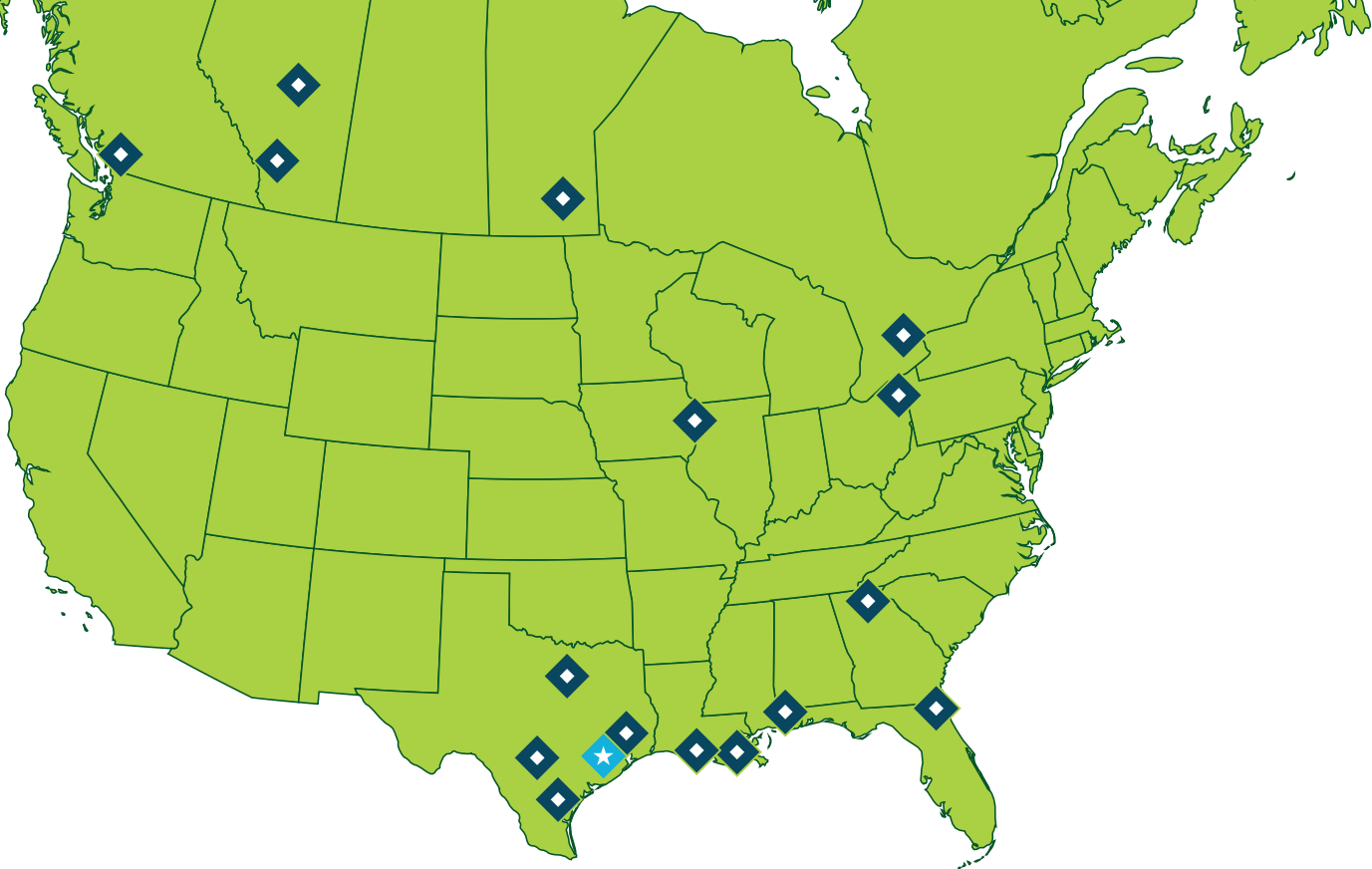

## ALLREDI THERE

Serving these industries: Bridge, Pipeline, Tank & Tower, Concrete Services, Rail, Shipyard & Marine, Pools & Fountains and Foundry

### UNITED STATES

**Pasadena, TX (Headquarters)**

844.361.7038

**Beaumont, TX**

409.722.1284

**Bristol, PA**

215.826.8080

**Corpus Christi, TX**

361.887.2038

**Davenport, IA**

563.324.2519

**Deer Park, TX**

(Service & Rental Location)

281.930.0905

**Duluth, GA**

800.535.4564

**Gonzales, LA**

225.647.7575

**Harvey, LA**

504.367.8090

**Houma, LA**

985.580.4273

**Jacksonville, FL**

904.262.2120

**Lafayette, LA**

337.267.1440

**Theodore, AL**

251.338.7525

**Youngstown, OH**

330.448.6267

### CANADA

**Calgary, Alberta**

403.279.1924

**Coquitlam, BC**

604.464.6979

**Edmonton, Alberta**

780.468.2588 (Manus)

780.425.5510 (Mod-U-Blast)

**Hamilton, Ontario**

905.527.6000 / 888.794.5665

**Mississauga, Ontario**

905.890.5837

**Winnipeg, Manitoba**

204.256.3324

**800-252-7848 / WWW.ALLREDI-US.COM**

Allredi™ and Marco® are registered trademarks of Allredi, LLC.

All other brand names or marks are used for identification purposes and are trademarks of their respective owners.



Literature #106M483\_8/24/22