

**✓ALLREDI™**



## **EDP 16HAZ FREE-AIR® PUMP**



**PART NUMBERS AND SCHEMATIC GUIDE**

## Company Profile

Allredi was formed in the early 2020, when two of the largest distributors in the blasting, coating, safety, and environmental industry, APE Companies and Marco Group International, joined forces. While the qualities both companies are known for have not changed, a lot about our business is new. New abilities. New agilities. New ways to help you win. This calls for a new name, Allredi.

This name exemplifies what we have become. It is completely oriented to the needs of our customers. To your needs. It says that when you call us for anything – products, service, expert advice, anything – you can consider it done. Or even better, Allredi done.

We are your right-now supplier. From skills to SKUs, we deliver the goods fast. So you can be more agile every minute, every day. This is who we are. This is what our new name means. Go ahead and expect excellence, because we're bringing it.

## Our Mission and Vision

To be the industry's preferred partner in surface preparation solutions through unrivaled technical expertise, customer experience, product availability, and tailored service offerings.

## The Allredi Difference

- **Industry Experience** – With Allredi on your team, you have access to expertise which can only come from decades of industry leadership. We have organized our engineering department, production specialists, customer operations, and safety support into a "Center of Competence." As an Allredi customer, you have access to hundreds of years of cumulative experience related to your operations.
- **Manufacturing Excellence** – Allredi is a U.S. based manufacturer of equipment for the Surface Preparation and Protective Coatings industries. Allredi's engineers benchmark the industry to ensure that we design and manufacture superior products that set the "Gold Standard" for performance, safety, and quality.
- **Legendary Customer Service** – Allredi's legendary customer service team is staffed by friendly, highly-trained individuals who are focused on providing the highest level of product support, order accuracy, and customer satisfaction.
- **Product Availability** – We stock over 10,000 SKU's and have over 45 shipping locations to serve North American and International markets for all major brands of blasting, coating, environmental, and safety equipment. Allredi is your right-now supplier, so you can keep your projects moving. From our foundation of strong relationships, we have built a nationwide network that puts vast inventory and ready service close to our customers. We provide advanced expertise, and we deliver the goods fast – so you can easily access the products and services you need to be more agile every minute, every day.
- **Technology Leadership** – Our website provides: Operator's Manuals, Part Numbers and Schematics Guides, SDS information, and key product features and specifications, providing access to information 24/7.

# TABLE OF CONTENTS

<b>Company Profile</b> .....	<b>2</b>
<b>Table of Contents</b> .....	<b>3</b>
<b>Bullard® EDP 16TE Free-Air® Pump</b> .....	<b>4-5</b>
Part Numbers .....	4
Part Numbers & Schematics .....	5
Optional Accessories .....	6
<b>Maintenance Notes</b> .....	<b>7</b>

# PART NUMBERS & SCHEMATICS GUIDE

<b>BULLARD® EDP 16HAZ FREE-AIR® PUMPS</b>				
<b>Part Numbers</b>	<b>Motor Type</b>	<b>Number of Outlets</b>	<b>CFM</b>	<b>Hazardous Duty</b>
<b>10BEDP16HAZ</b>	Electric-Driven	2	16	Yes

*\*Actual number of respirators that may be connected to these products is dependent on the inlet pressure to the panel, and the airflow and pressure requirements of the respirator.*

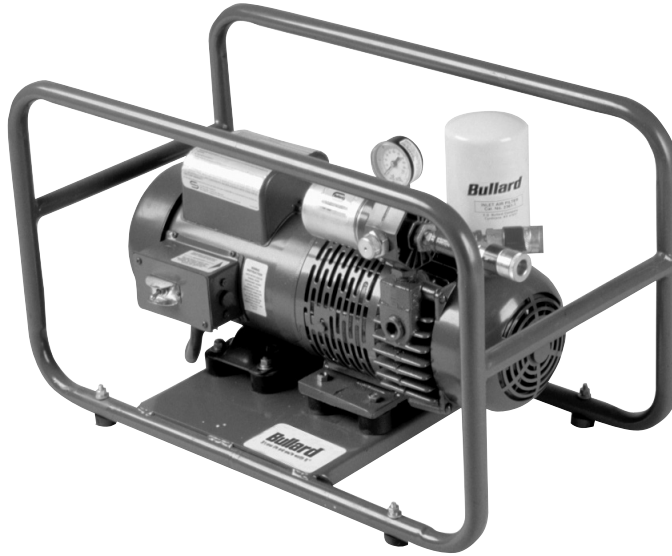





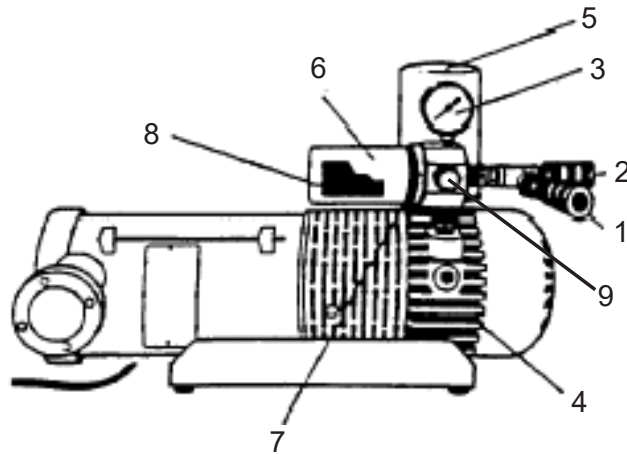





## PART NUMBERS & SCHEMATICS GUIDE

Figure 1: Bullard® EDP 16HAZ Free-Air® Pump



Item #	Part #	Description
<b>Fig. 1</b>		
—	<b>10BEDP16HAZ</b>	<b>Bullard® EDP 16HAZ Free-Air® Pump – Complete</b>
1	10BS16191	1/2" Industrial Interchange Quick-Disconnect Shut-Off With 3/8" NPT Pipe Thread
2	10BS16481	1/2" Industrial Interchange Quick-Disconnect Shut-Off With 3/8" NPT Pipe Thread
3	10BS19683	Pressure Gauge, Outlet Air Pressure, 0 – 30 psi
4	10B15922	Service Kit (Includes Item #'s: 5, 8, and four Carbon Vanes)
5	10B23611	Inlet Filter
6	10B244852	Outlet Filter Jar
7	10B263552	Outlet Filter Assembly O-Ring
8	10BS17101	Carbofine Outlet Filter Cartridge
9	10BEDP10PRV	Pressure Adjustment Knob
—	106M492	Part Numbers and Schematics Guide - Bullard® EDP 16HAZ Free-Air® Pump
—	109V492	Operator's Manual - Bullard® EDP 16HAZ Free-Air® Pump

## OPTIONAL ACCESSORIES

	Part Numbers	EDP 16HAZ FREE-AIR® PUMP ACCESSORIES
		Description
	10BV22	Quick-Disconnect Adapter, Converts Pumps Quick-Disconnect Coupler To Double 3/8" Female NPT
	10BV23	Quick-Disconnect Adapter, Converts Pumps Quick-Disconnect Coupler To Single 3/8" Female NPT
	10BF35B	1/2" Industrial Interchange Quick-Disconnect Constant Flow Coupling with Threaded Hose Connector and 10B4612 Belt
	10BV24	Quick-Disconnect Splitter/Adapter, Converts Pumps Quick-Disconnect Coupler To Double 1/2" Industrial Interchange Female Couplers ( <i>one flow-through, one shut-off</i> )
	10BINLINE16	Inline Filter Assembly for Remote Re-locating of Outlet
	10BS16483	1/2" Industrial Interchange Quick-Disconnect Coupling with 3/4" NPT Pipe Thread
	10B263552	Outlet Filter O-ring
	10BV50EX	Remote Extension Hose – 50 Ft.
	10BV50IN	Remote Inlet Air Hose And Fittings – 50 Ft.
	10BV2050ST	1/2" I.D. Breathing Line with 1/2" Male And Female Quick-Disconnect Coupling – 50 Ft.
	10BV20100ST	1/2" I.D. Breathing Line with 1/2" Male And Female Quick-Disconnect Coupling – 100 Ft.





## ALLREDI THERE

Serving these industries: Bridge, Pipeline, Tank & Tower, Concrete Services, Rail, Shipyard & Marine, Pools & Fountains and Foundry

### UNITED STATES

**Pasadena, TX (Headquarters)**

844.361.7038

**Beaumont, TX**

409.722.1284

**Bristol, PA**

215.826.8080

**Corpus Christi, TX**

361.887.2038

**Davenport, IA**

563.324.2519

**Deer Park, TX**

(Service & Rental Location)

281.930.0905

**Duluth, GA**

800.535.4564

**Gonzales, LA**

225.647.7575

**Harvey, LA**

504.367.8090

**Houma, LA**

985.580.4273

**Jacksonville, FL**

904.262.2120

**Lafayette, LA**

337.267.1440

**Theodore, AL**

251.338.7525

**Youngstown, OH**

330.448.6267

### CANADA

**Calgary, Alberta**

403.279.1924

**Coquitlam, BC**

604.464.6979

**Edmonton, Alberta**

780.468.2588 (Manus)

780.425.5510 (Mod-U-Blast)

**Hamilton, Ontario**

905.527.6000 / 888.794.5665

**Mississauga, Ontario**

905.890.5837

**Winnipeg, Manitoba**

204.256.3324

**800-252-7848 / WWW.ALLREDI-US.COM**

Allredi™ and Marco® are registered trademarks of Allredi, LLC.

All other brand names or marks are used for identification purposes and are trademarks of their respective owners.



Literature #106M492\_8/24/22