

✓ALLREDI™



BULLARD® ADP20 FREE-AIR® PUMP



PART NUMBERS AND SCHEMATIC GUIDE

Company Profile

Allredi was formed in the early 2020, when two of the largest distributors in the blasting, coating, safety, and environmental industry, APE Companies and Marco Group International, joined forces. While the qualities both companies are known for have not changed, a lot about our business is new. New abilities. New agilities. New ways to help you win. This calls for a new name, Allredi.

This name exemplifies what we have become. It is completely oriented to the needs of our customers. To your needs. It says that when you call us for anything – products, service, expert advice, anything – you can consider it done. Or even better, Allredi done.

We are your right-now supplier. From skills to SKUs, we deliver the goods fast. So you can be more agile every minute, every day. This is who we are. This is what our new name means. Go ahead and expect excellence, because we're bringing it.

Our Mission and Vision

To be the industry's preferred partner in surface preparation solutions through unrivaled technical expertise, customer experience, product availability, and tailored service offerings.

The Allredi Difference

- **Industry Experience** – With Allredi on your team, you have access to expertise which can only come from decades of industry leadership. We have organized our engineering department, production specialists, customer operations, and safety support into a "Center of Competence." As an Allredi customer, you have access to hundreds of years of cumulative experience related to your operations.
- **Manufacturing Excellence** – Allredi is a U.S. based manufacturer of equipment for the Surface Preparation and Protective Coatings industries. Allredi's engineers benchmark the industry to ensure that we design and manufacture superior products that set the "Gold Standard" for performance, safety, and quality.
- **Legendary Customer Service** – Allredi's legendary customer service team is staffed by friendly, highly-trained individuals who are focused on providing the highest level of product support, order accuracy, and customer satisfaction.
- **Product Availability** – We stock over 10,000 SKU's and have over 45 shipping locations to serve North American and International markets for all major brands of blasting, coating, environmental, and safety equipment. Allredi is your right-now supplier, so you can keep your projects moving. From our foundation of strong relationships, we have built a nationwide network that puts vast inventory and ready service close to our customers. We provide advanced expertise, and we deliver the goods fast – so you can easily access the products and services you need to me more agile every minute, every day.
- **Technology Leadership** – Our website provides: Operator's Manuals, Part Numbers and Schematics Guides, SDS information, and key product features and specifications, providing access to information 24/7.

TABLE OF CONTENTS

Company Profile	2
Table of Contents	3
Bullard ADP 20 Free-Air Pump	4-5
Part Number	4
Part Numbers & Schematics	5
Optional Accessories	6
Maintenance Notes	7

PART NUMBERS & SCHEMATICS GUIDE

BULLARD ADP 20 FREE-AIR PUMPS			
Part Numbers	Motor Type	Number of Outlets	CFM
10BADP20	Air-Driven	2	31

**Actual number of respirators that may be connected to these products is dependent on the inlet pressure to the panel, and the airflow and pressure requirements of the respirator.*







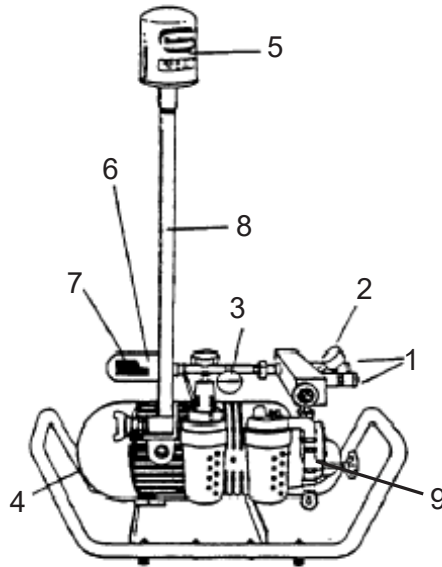



PART NUMBERS & SCHEMATICS GUIDE

Figure 1: ADP 20 Free-Air Pump



Item #	Part #	Description
Fig.1		
—	10BADP20	Bullard ADP 20 Free-Air Pump – Complete
1	10BS16191	1/2" Industrial Interchange Quick-Disconnect Shut-Off With 3/8" NPT Pipe Thread <i>(Two Included)</i>
2	10BS16222	Pressure Gauge, Outlet Air Pressure, 0 – 30 PSI NPT Pipe Thread
3	10BS09853	Pressure Gauge 0 – 200 PSI
4	10B15922	Service Kit <i>Includes Item #'s: 5, 7, and four Carbon Vanes</i>
5	10B23611	Inlet Filter
6	10B244852	Outlet Filter Jar
7	10BS17101	Carbofine Outlet Filter Cartridge
8	10B609400045	Air Inlet Stand Pipe
9	10B17761	Service Kit for Air Motor
—	10B609400072	Male Hex adapter
—	10B60980030	3/4" Female Coupling
—	106M493	Part Numbers and Schematics Guide - Bullard ADP 20 Free-Air Pump
—	109V493	Operator's Manual - Bullard ADP 20 Free-Air Pump

OPTIONAL ACCESSORIES

	Part Numbers	ADP 20 FREE-AIR PUMP ACCESSORIES
		Description
	10BV23	Quick-Disconnect Adapter, Converts Pumps Quick-Disconnect Coupler to Single 3/8" Female NPT
	10BS16191	1/2" Industrial Interchange Quick-Disconnect Shut-Off With 3/8" NPT Pipe Thread
	10BF35B	1/2" Industrial Interchange Quick-Disconnect Constant Flow Coupling with Threaded Hose Connector and 10B4612 Belt
	10B263552	Outlet Filter O-ring
	10BV50EX	Remote Extension Hose – 50 Ft.
	10BV50IN	Remote Inlet Air Hose And Fittings – 50 Ft.
	10BV2050ST	1/2" I.D. Breathing Line with 1/2" Male And Female Quick-Disconnect Coupling – 50 Ft.
	10BV20100ST	1/2" I.D. Breathing Line with 1/2" Male And Female Quick-Disconnect Coupling – 100 Ft.



ALLREDI THERE

Serving these industries: Bridge, Pipeline, Tank & Tower, Concrete Services, Rail, Shipyard & Marine, Pools & Fountains and Foundry

UNITED STATES

Pasadena, TX (Headquarters)

844.361.7038

Beaumont, TX

409.722.1284

Bristol, PA

215.826.8080

Corpus Christi, TX

361.887.2038

Davenport, IA

563.324.2519

Deer Park, TX

(Service & Rental Location)

281.930.0905

Duluth, GA

800.535.4564

Gonzales, LA

225.647.7575

Harvey, LA

504.367.8090

Houma, LA

985.580.4273

Jacksonville, FL

904.262.2120

Lafayette, LA

337.267.1440

Theodore, AL

251.338.7525

Youngstown, OH

330.448.6267

CANADA

Calgary, Alberta

403.279.1924

Coquitlam, BC

604.464.6979

Edmonton, Alberta

780.468.2588 (Manus)

780.425.5510 (Mod-U-Blast)

Hamilton, Ontario

905.527.6000 / 888.794.5665

Mississauga, Ontario

905.890.5837

Winnipeg, Manitoba

204.256.3324

800-252-7848 / WWW.ALLREDI-US.COM

Allredi™ and Marco® are registered trademarks of Allredi, LLC.

All other brand names or marks are used for identification purposes and are trademarks of their respective owners.

ALLREDI™

Literature #106M493_8/24/22