



BLAST HOSE, FITTINGS & ACCESSORIES



PART NUMBERS AND SCHEMATICS GUIDE

Company Profile

Allredi was formed in the early 2020, when two of the largest distributors in the blasting, coating, safety, and environmental industry, APE Companies and Marco Group International, joined forces. While the qualities both companies are known for have not changed, a lot about our business is new. New abilities. New agilities. New ways to help you win. This calls for a new name, Allredi.

This name exemplifies what we have become. It is completely oriented to the needs of our customers. To your needs. It says that when you call us for anything – products, service, expert advice, anything – you can consider it done. Or even better, Allredi done.

We are your right-now supplier. From skills to SKUs, we deliver the goods fast. So you can be more agile every minute, every day. This is who we are. This is what our new name means. Go ahead and expect excellence, because we're bringing it.

The Allredi Difference



- **Industry Experience** – With Allredi on your team, you have access to expertise which can only come from decades of industry leadership. We have organized our engineering department, production specialists, customer operations, and safety support into a "Center of Competence." As an Allredi customer, you have access to hundreds of years of cumulative experience related to your operations.
- **Manufacturing Excellence** – Allredi is a U.S. based manufacturer of equipment for the Surface Preparation and Protective Coatings industries. Allredi's engineers benchmark the industry to ensure that we design and manufacture superior products that set the "Gold Standard" for performance, safety, and quality.
- **Legendary Customer Service** – Allredi's legendary customer service team is staffed by friendly, highly-trained individuals who are focused on providing the highest level of product support, order accuracy, and customer satisfaction.
- **Product Availability** – We stock over 10,000 SKU's and have over 45 shipping locations to serve North American and International markets for all major brands of blasting, coating, environmental, and safety equipment. Allredi is your right-now supplier, so you can keep your projects moving. From our foundation of strong relationships, we have built a nationwide network that puts vast inventory and ready service close to our customers. We provide advanced expertise, and we deliver the goods fast – so you can easily access the products and services you need to me more agile every minute, every day.
- **Technology Leadership** – Our website provides: Operator's Manuals, Part Numbers and Schematics Guides, SDS information, and key product features and specifications, providing access to information 24/7.

TABLE OF CONTENTS

Company Profile	2
Table of Contents	3
Blast Hose	4-31
L-Series	4-5
1/2" I.D.	6-7
3/4" I.D.	8-9
1" I.D.	10-13
1-1/4" I.D.	14-17
1-1/2" I.D.	18-19
2" I.D.	20
Accessories	21-30
Couplings & Gaskets, Whip Check Safety Cables	21-24
Tank Couplings, Quick Disconnect Nozzle Holders	25-26
Nozzle Holders & Nozzle Washers	27-29
Coupling Safety Pins, Coupling Screws, Steel Wire Rolls.....	30
Hose Cutter.....	30
Anatomy of a Blast Hose	31

L-SERIES ABRASIVE BLASTING HOSE

L-SERIES ABRASIVE BLASTING HOSE								
Part Numbers	Hose I.D.	Hose O.D.	Fabric Reinforcement	Length (feet)	Working Pressure	Liner Thickness	Hose Layline Color	
			2-Ply			1/4" Heavy-Duty	White	
	10BH0384BR	3/8"	47/64"	X	Per Foot	150 psi	X	X

L-SERIES ABRASIVE BLASTING HOSE WITH COUPLINGS INSTALLED										
Part Numbers	Hose I.D.	Hose O.D.	Length (feet)	Fabric Reinforcement	Working Pressure (psi)	Liner Thickness	Hose Layline Color	Coupling(s)		
				2-Ply		1/4"	White	Aluminum	Steel	
	10BH038B10AC	3/8"	47/64"	10'	X	150	X	X	X	X
	10L850119	1/2"	1-3/16"	10'	X	150	X	X	X	X
	1081226	1/2"	1-3/16"	25'	X	150	X	X	X	X
	10L850120	1/2"	1-3/16"	25'	X	150	X	X	X	X
	10L850125	1/2"	1-3/16"	50'	X	150	X	X	X	X
	10L850122	3/4"	1-1/2"	25'	X	150	X	X	X	X
	10L850123	3/4"	1-1/2"	50'	X	150	X	X	X	X

L-SERIES ABRASIVE BLASTING HOSE

	Part Numbers	INTERNAL HOSE END FITTING FOR 47/64" O.D. ABRASIVE BLASTING HOSE
	1017021	Steel

	Part Numbers	HOSE END FITTING FOR 1/2" I.D. ABRASIVE BLASTING HOSE
	10L174	Steel

L-SERIES ABRASIVE BLASTING POT HOSE END ASSEMBLY

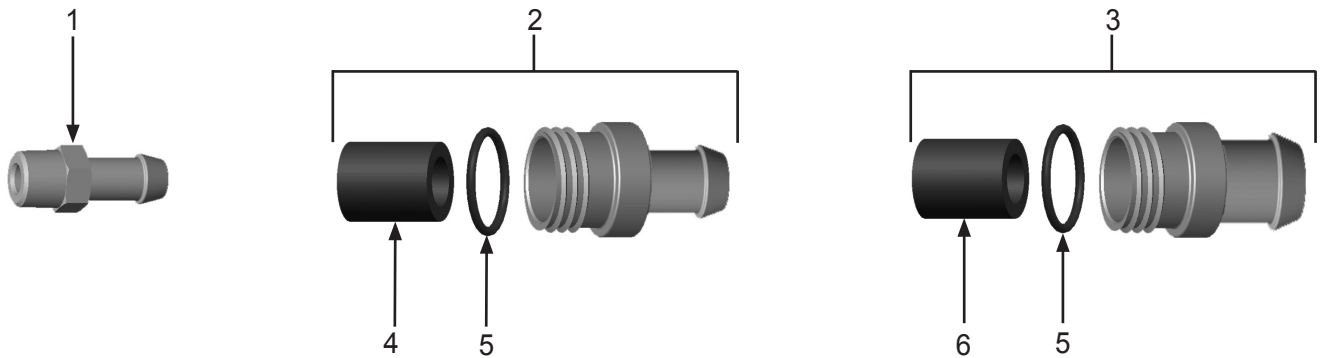



Item #	Part #	Description
1	10L174	Hose End for 1/2" I.D. Abrasive Blasting Hose
2	10L366HE	Hose End for 3/4" I.D. Abrasive Blasting Hose (Includes Item #'s: 4 and 5)
3	10L466HE	Hose End for 1" I.D. Abrasive Blasting Hose (Includes Item #'s: 5 and 6)
4	10L800236	Rubber Liner for 3/4" I.D. Abrasive Blasting Hose
5	10L66RR	O-ring
6	10L800237	Rubber Liner for 1" I.D. Abrasive Blasting Hose



MARCO® 1/2" I.D. ABRASIVE BLASTING HOSE

		1/2" I.D. ABRASIVE BLASTING HOSE					
Part Numbers		O.D.	Length (feet)	2-Ply Fabric Reinforcement	Working Pressure	1/4" Tube Thickness	White Layline*
	10BH012B	1-1/16"	50'	X	150 psi	X	X
	10BH012E	1-1/8"	50'	X	150 psi	X	X
	10BH0122CR	1-3/16"	Per Foot	X	150 psi	X	X
	10BH012C	1-3/16"	50'	X	150 psi	X	X
	10BH0124C	1-3/16"	400'	X	150 psi	X	X

**Layline color is subject to change to red at any time.*

MARCO® 1/2" I.D. ABRASIVE BLASTING HOSE

		COUPLINGS FOR 1/2" I.D. ABRASIVE BLASTING HOSE						
Part Numbers		Hose O.D.	Material	Lug Style		Gasket Options		
				Standard	Oversized	Rubber	Urethane	Gasket I.D.
	10QAL050	1-1/16"	Aluminum	X		10SBG	10USBG	1-1/4"
	10EM505222	1/1/8"	Steel	X		10SBG	10USBG	1-1/4"
	10QAL12	1-3/16"	Aluminum	X		10SBG	10USBG	1-1/4"

		NOZZLE HOLDERS FOR 1/2" I.D. ABRASIVE BLASTING HOSE			
Part Numbers		Hose O.D.	Material	Thread Style	Nozzle Washer
	10NHA050	1-1/16"	Aluminum	3/4" NPS	10NW1
	10NHA12	1-3/16"	Aluminum	3/4" NPS	10NW1

MARCO® 3/4" I.D. ABRASIVE BLASTING HOSE

		3/4" I.D. X 1-1/2" O.D. ABRASIVE BLASTING HOSE				
Part Numbers		4-Ply Fabric Reinforcement	Length (feet)	Working Pressure	1/4" Tube Thickness	White Layline*
	10BH0342BR	X	Per Foot	150 psi	X	X
	10BH034B	X	50'	150 psi	X	X
	10BH0344B	X	400'	150 psi	X	X





*Layline color is subject to change to red at any time.







		3/4" I.D. X 1-1/2" O.D. ABRASIVE BLASTING HOSE WITH COUPLING AND NOZZLE HOLDER INSTALLED											
Part Numbers		2-Ply Fabric Reinforcement**	Length (feet)	Working Pressure	1/4" Tube Thickness	White Layline*	Coupling(s)				Nozzle Holder		
							Aluminum	Brass	Iron	Nylon	Aluminum	Brass	Nylon
	1081214	X	10'	150 psi	X	X	X				X		
	1081216	X	10'	150 psi	X	X		X				X	
	1081224	X	10'	150 psi	X	X		X			X		
	1081215	X	12.5'	150 psi	X	X	X				X		
	1081217	X	12.5'	150 psi	X	X		X				X	
	1081228	X	25'	150 psi	X	X	X				X		
	1081225	X	25'	150 psi	X	X				X			X

*Layline color is subject to change to red at any time.

**Number of plies is subject to change to 4-Ply at any time.





MARCO® 3/4" I.D. ABRASIVE BLASTING HOSE

Part Numbers		COUPLINGS FOR 1-1/2" O.D. ABRASIVE BLASTING HOSE						
		Material	Lug Style		Gasket Options			Hose O.D.
			Standard	Oversized	Rubber	Urethane	Gasket I.D.	
	10QAL1	Aluminum	X		10SBG	10USBG	1-1/4"	1-1/2"
	10QBR1	Brass	X		10SBG	10USBG	1-1/4"	1-1/2"
	10QIR1	Iron	X		10SBG	10USBG	1-1/4"	1-1/2"
	10QNY1	Nylon	X		10SBGNY1	—	3/4"	1-1/2"







Part Numbers		NOZZLE HOLDERS FOR 1-1/2" O.D. ABRASIVE BLASTING HOSE			
		Material	Thread Style	Nozzle Washer	Hose O.D.
	10NHA1	Aluminum	1-1/4" NPS	10NW	1-1/2"
	10NHA150	Aluminum	50MM	—	1-1/2"
	10NHB1	Brass	1-1/4" NPS	10NW	1-1/2"
	10NHB150	Brass	50MM	—	1-1/2"
	10NHN1	Nylon	1-1/4" NPS	10NW	1-1/2"
	10NHN150	Nylon	50MM	10NW50	1-1/2"

MARCO® 1" I.D. SUPER-FLEX ABRASIVE BLASTING HOSE

		1" I.D. X 1-1/2" O.D. SUPER-FLEX ABRASIVE BLASTING HOSE				
	Part Numbers	2-Ply Fabric Reinforcement	Length (feet)	Working Pressure	1/8" Liner Thickness	Tan Layline

		COUPLINGS FOR 1-1/2" O.D. ABRASIVE BLASTING HOSE						
	Part Numbers	Material	Lug Style		Gasket Options			Hose O.D.
			Standard	Oversized	Rubber	Urethane	Gasket I.D.	
	10QAL1	Aluminum	X		10SBG	10USBG	1-1/4"	1-1/2"
	10QBR1	Brass	X		10SBG	10USBG	1-1/4"	1-1/2"
	10QIR1	Iron	X		10SBG	10USBG	1-1/4"	1-1/2"
	10C21088	Nylon	X		10SBGNY2	—	1-1/4"	1-1/2"

MARCO® 1" I.D. SUPER-FLEX ABRASIVE BLASTING HOSE

		NOZZLE HOLDERS FOR 1-1/2" O.D. ABRASIVE BLASTING HOSE			
Part Numbers		Material	Thread Style	Nozzle Washer	Hose O.D.
	10NHA1	Aluminum	1-1/4" NPS	10NW	1-1/2"
	10NHA150	Aluminum	50MM	—	1-1/2"
	10NHB1	Brass	1-1/4" NPS	10NW	1-1/2"
	10NHB150	Brass	50MM	—	1-1/2"
	10NHN1	Nylon	1-1/4" NPS	10NW	1-1/2"
	10NHN150	Nylon	50MM	10NW50	1-1/2"







MARCO® 1" I.D. ABRASIVE BLASTING HOSE







		1" I.D. X 1-7/8" O.D. ABRASIVE BLASTING HOSE				
Part Numbers		5/16" Xtreme-Duty® Liner Thickness	Length (Ft.)	4-Ply Fabric Reinforcement	Working Pressure	Red Layline
	10BH1002XR	X	Per Foot	X	150 psi	X
	10BH100X	X	50'	X	150 psi	X
	10BH1004X	X	400'	X	150 psi	X

		1" I.D. X 1-7/8" O.D. ABRASIVE BLASTING HOSE WITH COUPLING AND NOZZLE HOLDER INSTALLED											
Part Numbers		5/16" Xtreme-Duty® Liner Thickness	Length (feet)	4-Ply Fabric Reinforcement	Working Pressure	Red Layline	Coupling(s)				Nozzle Holder		
							Aluminum	Brass	Iron	Nylon	Aluminum	Brass	Nylon
	1081300	X	10'	X	150 psi	X	X				X		
	1081301	X	10'	X	150 psi	X		X			X		
	1081302	X	12.5'	X	150 psi	X	X				X		
	1081303	X	12.5'	X	150 psi	X		X			X		
	1081212	X	50'	X	150 psi	X				X			X

		1" I.D. X 1-7/8" O.D. ABRASIVE BLASTING HOSE WITH COUPLINGS INSTALLED										
Part Numbers		5/16" Xtreme-Duty® Liner Thickness	Length (feet)	4-Ply Fabric Reinforcement	Working Pressure	Red Layline	Coupling(s)					
							Aluminum	Brass	Iron	Nylon	Steel	
	10BH100XAC	X	50'	X	150 psi	X	X					

MARCO® 1" I.D. ABRASIVE BLASTING HOSE

Part Numbers		COUPLINGS FOR 1-7/8" O.D. ABRASIVE BLASTING HOSE						
		Material	Lug Style		Gasket Options			Hose O.D.
			Standard	Oversized	Rubber	Urethane	Gasket I.D.	
	10QAL2	Aluminum	X		10SBG	10USBG	1-1/4"	1-7/8"
	10QAL2X	Aluminum		X	10SBG2	—	1-3/4"	1-7/8"
	10QBR2	Brass	X		10SBG	10USBG	1-1/4"	1-7/8"
	10QBR2X	Brass		X	10SBG2	—	1-3/4"	1-7/8"
	10QIR2	Iron	X		10SBG	10USBG	1-1/4"	1-7/8"
	10QNY2	Nylon	X		10SBGNY2	—	1-1/4"	1-7/8"







Part Numbers		NOZZLE HOLDERS FOR 1-7/8" O.D. ABRASIVE BLASTING HOSE			
		Material	Thread Style	Nozzle Washer	Hose O.D.
	10NHA2	Aluminum	1-1/4" NPS	10NW	1-7/8"
	10NHA250	Aluminum	50MM	—	1-7/8"
	10NHB2	Brass	1-1/4" NPS	10NW	1-7/8"
	10NHB250	Brass	50MM	—	1-7/8"
	10NHN2	Nylon	1-1/4" NPS	10NW	1-7/8"
	10NHN250	Nylon	50MM	10NW50	1-7/8"







MARCO® 1-1/4" I.D. SUPER-FLEX ABRASIVE BLASTING HOSE

		1-1/4" I.D. X 1-7/8 O.D. SUPER-FLEX ABRASIVE BLASTING HOSE				
Part Numbers		2-Ply Fabric Reinforcement	Length (feet)	Working Pressure	1/4" Liner Thickness	Tan Layline
	10SH1142R	X	Per Foot	175 psi	X	X
	10SH114	X	50'	175 psi	X	X
	10SH1141	X	100'	175 psi	X	X
	10SH1144	X	400'	175 psi	X	X

		1-1/4" I.D. X 1-7/8" O.D. ABRASIVE BLASTING HOSE WITH COUPLING AND NOZZLE HOLDER INSTALLED											
Part Numbers		2-Ply Fabric Reinforcement	Length (feet)	Working Pressure	1/4" Liner Thickness	Tan Layline	Coupling(s)				Nozzle Holder		
							Aluminum	Brass	Iron	Nylon	Aluminum	Brass	Nylon
	1081204	X	10'	175 psi	X	X	X				X		
	1081206	X	10'	175 psi	X	X		X				X	
	1081207	X	12.5'	175 psi	X	X	X				X		
	1081208	X	12.5'	175 psi	X	X		X				X	
	1081221	X	50'	175 psi	X	X	X				X		
	1081229	X	50'	175 psi	X	X				X			1-1/4"
	1081213	X	50'	175 psi	X	X				X			50MM

MARCO® 1-1/4" I.D. SUPER-FLEX ABRASIVE BLASTING HOSE

		COUPLINGS FOR 1-7/8" O.D. ABRASIVE BLASTING HOSE						
Part Numbers		Material	Lug Style		Gasket Options			Hose O.D.
			Standard	Oversized	Rubber	Urethane	Gasket I.D.	
	10QAL2	Aluminum	X		10SBG	10USBG	1-1/4"	1-7/8"
	10QAL2X	Aluminum		X	10SBG2	—	1-3/4"	1-7/8"
	10QBR2	Brass	X		10SBG	10USBG	1-1/4"	1-7/8"
	10QBR2X	Brass		X	10SBG2	—	1-3/4"	1-7/8"
	10QIR2	Iron	X		10SBG	10USBG	1-1/4"	1-7/8"
	10QNY2	Nylon	X		10SBGNY2	—	1-1/4"	1-7/8"







		NOZZLE HOLDERS FOR 1-7/8" O.D. ABRASIVE BLASTING HOSE			
Part Numbers		Material	Thread Style	Nozzle Washer	Hose O.D.
	10NHA2	Aluminum	1-1/4" NPS	10NW	1-7/8"
	10NHA250	Aluminum	50MM	—	1-7/8"
	10NHB2	Brass	1-1/4" NPS	10NW	1-7/8"
	10NHB250	Brass	50MM	—	1-7/8"
	10NHN2	Nylon	1-1/4" NPS	10NW	1-7/8"
	10NHN250	Nylon	50MM	10NW50	1-7/8"







MARCO® 1-1/4" I.D. ABRASIVE BLASTING HOSE

		1-1/4" I.D. X 2-5/32" O.D. ABRASIVE BLASTING HOSE						
		5/16" Xtreme-Duty® Liner Thickness	Length (feet)	Fabric Reinforcement	Working Pressure	Hose Layline Color		
4-Ply	White			Red				
	Part Numbers	10BH1142XR	X	Per Foot	X	150 psi		X
	10BH114X	X	50'	X	150 psi		X	
	10BH1141X	X	100'	X	150 psi		X	
	10BH1144X	X	400'	X	150 psi		X	

		1-1/4" I.D. X 2-5/32" O.D. ABRASIVE BLASTING HOSE WITH COUPLINGS INSTALLED										
		5/16" Xtreme-Duty® Liner Thickness	Length (feet)	Fabric Reinforcement	Working Pressure	Hose Layline Color		Coupling(s)				
4-Ply	White			Red		Aluminum	Brass	Iron	Nylon			
	Part Numbers	10BH114XAC	X	50'	X	150 psi		X	X			
	10BH114XBC	X	50'	X	150 psi		X		X			

MARCO® 1-1/4" I.D. ABRASIVE BLASTING HOSE

Part Numbers		COUPLINGS FOR 2-5/32" O.D. ABRASIVE BLASTING HOSE						
		Material	Lug Style		Gasket Options			Hose O.D.
			Standard	Oversized	Rubber	Urethane	Gasket I.D.	
	10QAL3	Aluminum	X		10SBG	10USBG	1-1/4"	2-5/32"
	10QAL3X	Aluminum		X	10SBG2	—	1-3/4"	2-5/32"
	10QBR3	Brass	X		10SBG	10USBG	1-1/4"	2-5/32"
	10QBR3X	Brass		X	10SBG2	—	1-3/4"	2-5/32"
	10QIR3	Iron	X		10SBG	10USBG	1-1/4"	2-5/32"
	10QNY3	Nylon	X		10SBGNY2	—	1-1/4"	2-5/32"







Part Numbers		NOZZLE HOLDERS FOR 2-5/32" O.D. ABRASIVE BLASTING HOSE			
		Material	Thread Style	Nozzle Washer	Hose O.D.
	10NHA3	Aluminum	1-1/4" NPS	10NW	2-5/32"
	10NHA350	Aluminum	50MM	—	2-5/32"
	10NHB3	Brass	1-1/4" NPS	10NW	2-5/32"
	10NHB350	Brass	50MM	—	2-5/32"
	10NHN3	Nylon	1-1/4" NPS	10NW	2-5/32"
	10NHN350	Nylon	50MM	10NW50	2-5/32"





MARCO® 1-1/2" I.D. ABRASIVE BLASTING HOSE

		1-1/2" I.D. X 2-3/8" O.D. ABRASIVE BLASTING HOSE				
	Part Numbers	5/16" Xtreme-Duty® Liner Thickness	Length (feet)	4-Ply Fabric Reinforcement	Working Pressure	Red Layline
	10BH112X	X	50'	X	150 psi	X
	10BH1121X	X	100'	X	150 psi	X
	10BH1124X	X	400'	X	150 psi	X

		1-1/2" I.D. X 2-3/8" O.D. ABRASIVE BLASTING HOSE WITH COUPLINGS INSTALLED								
	Part Numbers	5/16" Xtreme-Duty® Liner Thickness	Length (feet)	4-Ply Fabric Reinforcement	Working Pressure	Red Layline	Coupling(s)			
							Aluminum	Brass	Iron	Nylon
	10BH112XAC	X	50'	X	150 psi	X	X			
	10BH112XBC	X	50'	X	150 psi	X		X		



MARCO® 1-1/2" I.D. ABRASIVE BLASTING HOSE

Part Numbers		COUPLINGS FOR 2-3/8" O.D. ABRASIVE BLASTING HOSE						
		Material	Lug Style		Gasket Options			Hose O.D.
			Standard	Oversized	Rubber	Urethane	Gasket I.D.	
	10QAL4	Aluminum	X		10SBG	10USBG	1-1/4"	2-3/8"
	10QAL4X	Aluminum		X	10SBG2	—	1-3/4"	2-3/8"
	10QBR4	Brass	X		10SBG	10USBG	1-1/4"	2-3/8"
	10QBR4X	Brass		X	10SBG2	—	1-3/4"	2-3/8"
	10QIR4	Iron	X		10SBG	10USBG	1-1/4"	2-3/8"
	10QNY4	Nylon	X		10SBGNY2	—	1-1/4"	2-3/8"











Part Numbers		NOZZLE HOLDERS FOR 2-3/8" O.D. ABRASIVE BLASTING HOSE			
		Material	Thread Style	Nozzle Washer	Hose O.D.
	10NHA4	Aluminum	1-1/4"	10NW	2-3/8"
	10NHA450	Aluminum	50MM	—	2-3/8"
	10NHB4	Brass	1-1/4"	10NW	2-3/8"
	10NHB450	Brass	50MM	—	2-3/8"

MARCO® 2" I.D. ABRASIVE BLASTING HOSE

		2" I.D. X 2-7/8" O.D. ABRASIVE BLASTING HOSE				
	Part Numbers	4-Ply Fabric Reinforcement	Working Pressure	Length (feet)	1/4" Heavy-Duty Liner Thickness	Red Layline
		10BH200B	X	150 psi	50'	X
10BH2001B	X	150 psi	100'	X	X	

		COUPLINGS FOR 2-7/8" O.D. ABRASIVE BLASTING HOSE						
	Part Numbers	Material	Lug Style		Gasket Options			Hose O.D.
			Standard	Oversized	Rubber	Urethane	Gasket I.D.	
	10QAL6X	Aluminum		X	10SBG2	—	1-3/4"	2-7/8"
	10QBR6X	Brass		X	10SBG2	—	1-3/4"	2-7/8"

BLAST HOSE ACCESSORIES

Part Numbers		COUPLINGS AND GASKETS						
		Material	Lug Style		Gasket Options			Hose O.D.
			Standard	Oversized	Rubber	Urethane	Gasket I.D.	
	10QAL050	Aluminum	X		10SBG	10USBG	1-1/4"	1-1/16"
	10QAL12	Aluminum	X		10SBG	10USBG	1-1/4"	1-3/16"
	10QAL1	Aluminum	X		10SBG	10USBG	1-1/4"	1-1/2"
	10QAL2	Aluminum	X		10SBG	10USBG	1-1/4"	1-7/8"
	10QAL3	Aluminum	X		10SBG	10USBG	1-1/4"	2-5/32"
	10QAL4	Aluminum	X		10SBG	10USBG	1-1/4"	2-3/8"
	10QAL2X	Aluminum		X	10SBG2	—	1-3/4"	1-7/8"
	10QAL3X	Aluminum		X	10SBG2	—	1-3/4"	2-5/32"
	10QAL4X	Aluminum		X	10SBG2	—	1-3/4"	2-3/8"
	10QAL6X	Aluminum		X	10SBG2	—	1-3/4"	2-7/8"

BLAST HOSE ACCESSORIES











Part Numbers		COUPLINGS AND GASKETS						
		Material	Hose O.D.	Lug Style		Gasket Options		
				Standard	Oversized	Rubber	Urethane	Gasket I.D.
	10QBR1	Brass	1-1/2"	X		10SBG	10USBG	1-1/4"
	10QBR2	Brass	1-7/8"	X		10SBG	10USBG	1-1/4"
	10QBR3	Brass	2-5/32"	X		10SBG	10USBG	1-1/4"
	10QBR4	Brass	2-3/8"	X		10SBG	10USBG	1-1/4"
	10QBR2X	Brass	1-7/8"		X	10SBG2	—	1-3/4"
	10QBR3X	Brass	2-5/32"		X	10SBG2	—	1-3/4"
	10QBR4X	Brass	2-3/8"		X	10SBG2	—	1-3/4"
	10QBR6X	Brass	2-7/8"		X	10SBG2	—	1-3/4"



BLAST HOSE ACCESSORIES

Part Numbers		COUPLINGS AND GASKETS						
		Material	Hose O.D.	Lug Style		Gasket Options		
				Standard	Oversized	Rubber	Urethane	Gasket I.D.
	10QIR1	Iron	1-1/2"	X		10SBG	10USBG	1-1/4"
	10QIR2	Iron	1-7/8"	X		10SBG	10USBG	1-1/4"
	10QIR3	Iron	2-5/32"	X		10SBG	10USBG	1-1/4"
	10QIR4	Iron	2-3/8"	X		10SBG	10USBG	1-1/4"
	10QNY1	Nylon	1-1/2"	X		10SBGNY1	—	1-1/4"
	10C21088*	Nylon	1-1/2"	X		10SNGNY2	—	1-1/4"
	10QNY2	Nylon	1-7/8"	X		10SBGNY2	—	1-1/4"
	10QNY3	Nylon	2-5/32"	X		10SBGNY2	—	1-1/4"
	10QNY4	Nylon	2-3/8"	X		10SBGNY2	—	1-1/4"
	1017021	Steel	—			—	—	—
	10EM505222	Steel	1-1/8"	X		10SBG	10USBG	1-1/4"











*For use with 10SH100 only.

BLAST HOSE ACCESSORIES





		COUPLING GASKETS				
		Part Numbers	Coupling Material	Coupling Style	Gasket I.D.	U.O.M.
		10SBG	Metal	2-Lug	1-1/4"	10/Package
		10USBG	Metal	2-Lug	1-1/4"	10/Package
		10SBG2	Metal	Oversized	1-3/4"	10/Package
		10SBGNY1	Nylon	2-Lug	3/4" – 1-1/4"	10/Package
		10SBGNY2	Nylon	2-Lug	1-1/4"	10/Package

		WHIP CHECK SAFETY CABLES	
		Part Numbers	Description
	1018000	For Hose O.D. ranging from 15/16" to 2-5/32"	One Each
	1018001	For Hose O.D. ranging from 2-1/32" to 3-5/8"	One Each
	1070810	36" Nylon Whip Check	One Each

BLAST HOSE ACCESSORIES

		TANK COUPLINGS				
		Material	Lug Style		Threads	Coupling Gasket
			Standard	Oversized		
Part Numbers						
	10SA3X	Aluminum		X	1-1/2" NPT	10SBG or 10USBG
	10SA4X	Aluminum		X	2" NPT	10SBG2
	10SB1S	Brass	X		1-1/4" NPS	10SBG or 10USBG
	10SB1	Brass	X		1-1/4" NPT	10SBG or 10USBG
	10SB2S	Brass	X		1-1/2" NPS	10SBG or 10USBG
	10SB2	Brass	X		1-1/2" NPT	10SBG or 10USBG
	10SB3X	Brass		X	1-1/2" NPT	10SBG2
	10SB4X	Brass		X	2" NPT	10SBG2
	10IRSB1	Iron	X		1-1/4" NPT	10SBG or 10USBG
	10IRSB2	Iron	X		1-1/2" NPT	10SBG or 10USBG









BLAST HOSE ACCESSORIES

	Part Numbers	QUICK DISCONNECT NOZZLE HOLDERS			
		Material	Thread Style	Standard Lugs	Coupling Gasket
	10NHAQ	Aluminum	1-1/4"	X	10SBG or 10USBG
	10NHAQF	Aluminum	Flanged	X	10SBG or 10USBG
	10NHBQF	Brass	Flanged	X	10SBG or 10USBG
	10C07716	Nylon	1-1/4"	X	10SBGNY2
	10C07719	Nylon	50MM	X	10SBGNY2







BLAST HOSE ACCESSORIES



		NOZZLE HOLDERS & NOZZLE WASHERS			
Part Numbers		Material	Thread Style	Nozzle Washer	Hose O.D.
	10NHA050	Aluminum	3/4"	10NW1	1-1/16"
	10NHA12	Aluminum	3/4"	10NW1	1-3/16"
	10NHA1	Aluminum	1-1/4"	10NW	1-1/2"
	10NHA2	Aluminum	1-1/4"	10NW	1-7/8"
	10NHA3	Aluminum	1-1/4"	10NW	2-5/32"
	10NHA4	Aluminum	1-1/4"	10NW	2-3/8"
	10NHA150	Aluminum	50MM	—	1-1/2"
	10NHA250	Aluminum	50MM	—	1-7/8"
	10NHA350	Aluminum	50MM	—	2-5/32"
	10NHA450	Aluminum	50MM	—	2-3/8"

BLAST HOSE ACCESSORIES



		NOZZLE HOLDERS & NOZZLE WASHERS			
Part Numbers		Material	Thread Style	Nozzle Washer	Hose O.D.
	10NHB1	Brass	1-1/4"	10NW	1-1/2"
	10NHB2	Brass	1-1/4"	10NW	1-7/8"
	10NHB3	Brass	1-1/4"	10NW	2-5/32"
	10NHB4	Brass	1-1/4"	10NW	2-3/8"
	10NHB150	Brass	50MM	—	1-1/2"
	10NHB250	Brass	50MM	—	1-7/8"
	10NHB350	Brass	50MM	—	2-5/32"
	10NHB450	Brass	50MM	—	2-3/8"



BLAST HOSE ACCESSORIES



		NOZZLE HOLDERS & NOZZLE WASHERS			
Part Numbers		Material	Thread Style	Nozzle Washer	Hose O.D.
	10NHN1	Nylon	1-1/4"	10NW	1-1/2"
	10NHN2	Nylon	1-1/4"	10NW	1-7/8"
	10NHN3	Nylon	1-1/4"	10NW	2-5/32"
	10NHN150	Nylon	50MM	10NW50	1-1/2"
	10NHN250	Nylon	50MM	10NW50	1-7/8"
	10NHN350	Nylon	50MM	10NW50	2-5/32"

		NOZZLE WASHERS	
Part Numbers		Gasket I.D.	U.O.M.
	10NW1	3/4"	10/Package
	10NW	1"	10/Package
	10NW50	1-1/4"	10/Package

BLAST HOSE ACCESSORIES

		COUPLING SCREWS			
Part Numbers		Type	Drive	Length	U.O.M.
	10HCS	Flat Head	Phillips	1/2"	50/Package
	10RHCS	Round Head	Phillips	1/2"	50/Package
	10HCSX	Round Head	Phillips	3/4"	One Each

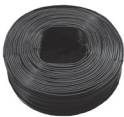
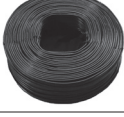
		COUPLING SAFETY PINS	
Part Numbers		Description	U.O.M.
	1018002	Coupling Safety Pins	25/Package
	1070095	Oversized Coupling Safety Pin	One Each

		STEEL WIRE ROLLS					
Part Numbers		Steel Material	Type	Gauge	Length (Approximate)	Weight	U.O.M.
	1070483	Carbon	Coated	9	1,700 Ft	100 lbs.	One Each
	1070078	Carbon	Coated	16	336 Ft.	3.5 lbs.	One Each
	10DPL081067	Stainless	Uncoated	16	330 Ft.	3.5 lbs.	One Each

		HOSE CUTTER
	10DXLHC95	Hose and PVC Cutter for Hose up to 1-7/8" O.D.
<i>no image available</i>	10DXLHC95RB	Replacement Blade for Hose Cutter (<i>one each</i>)

ANATOMY OF A BLAST HOSE

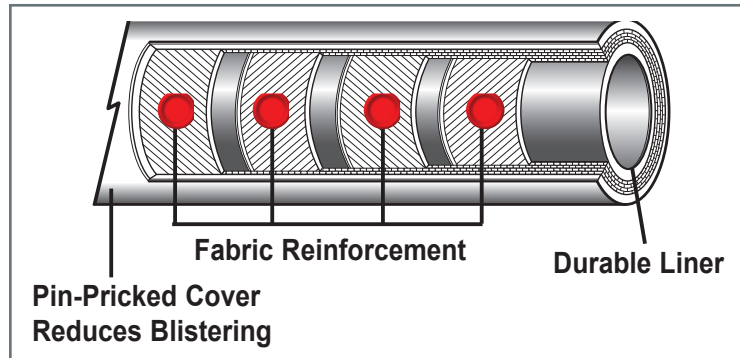

1. COVER

Marco® Blast Hose has an abrasion resistant hose cover that stands up to dragging across rough surfaces. Every Marco® Blast Hose is constructed with a durable, UV resistant protective cover that resists tearing, puncturing, and aging from exposure to the sun.

2. FABRIC REINFORCEMENT

The fabric hose reinforcement, referred to as the cord or ply, is the back bone of the hose and maintains the structural integrity of the hose. It determines the rigidity of the hose while providing the integrity to withstand the higher air pressure commonly used in production-oriented applications. Marco® Blast Hose is available in 4-ply construction for increased structural integrity and 2-ply construction for improved flexibility.

3. DURABLE LINER

The liner of the blasting hose truly determines how long the hose will last. A carefully selected material compound of gum rubber to resist wear from passing abrasive, additional polymers to protect the liner from drying out, and carbon black has been added to dissipate static electricity.



ALLREDI THERE

Serving these industries: Bridge, Pipeline, Tank & Tower, Concrete Services, Rail, Shipyard & Marine, Pools & Fountains and Foundry

UNITED STATES

Pasadena, TX (*Headquarters*)
844.361.7038

Beaumont, TX
409.722.1284

Bristol, PA
215.826.8080

Corpus Christi, TX
361.887.2038

Davenport, IA
563.324.2519

Deer Park, TX
(*Service & Rental Location*)
281.930.0905

Duluth, GA
800.535.4564

Gonzales, LA
225.647.7575

Harvey, LA
504.367.8090

Houma, LA
985.580.4273

Jacksonville, FL
904.262.2120

Lafayette, LA
337.267.1440

Theodore, AL
251.338.7525

Youngstown, OH
330.448.6267

CANADA

Calgary, Alberta
403.279.1924

Coquitlam, BC
604.464.6979

Edmonton, Alberta
780.468.2588 (Manus)
780.425.5510 (Mod-U-Blast)

Hamilton, Ontario
905.527.6000 / 888.794.5665

Mississauga, Ontario
905.890.5837

Winnipeg, Manitoba
204.256.3324

800-252-7848 / WWW.ALLREDI-US.COM

Allredi™ and Marco® are registered trademarks of Allredi, LLC.
All other brand names or marks are used for identification purposes and are trademarks of their respective owners.

ALLREDI™

Literature #106M030_4/26/2022