



BARRICADE® CARBON MONOXIDE MONITOR



BUILT MARCO TOUGH
MARCO MANUFACTURED

PART NUMBERS AND SCHEMATICS GUIDE

Company Profile

Since 1944, Marco has developed a strong tradition of providing innovative and reliable products and services to the surface preparation and protective coatings industries. We are the world's premier provider of Abrasives, Blasting, Coating, Dust Collectors, Engineered Systems, Rental, Safety, Service, Repair, & Modernization, and Vacuums.

Through innovative designs and a total commitment to quality, Marco manufactures products that increase production rates, create a safer workplace, and reduce maintenance costs. Marco's industry experience, manufacturing capabilities, legendary customer service, product availability, logistics services, and technology leadership is your assurance that we deliver high quality products and services, providing the best value to you, our customer.

The Marco Difference

- **Industry Experience** – With Marco on your team, you have access to expertise which can only come from decades of industry leadership. We have organized our engineering department, production specialists, customer operations, and safety support into a “Center of Competence.” As a Marco customer, you have access to hundreds of years of cumulative experience related to your operations.
- **Manufacturing Excellence** – Marco is a U.S. based, ISO 9001:2008 certified manufacturer of equipment for the Surface Preparation and Protective Coatings industries. Marco's engineers benchmark the industry to ensure that we design and manufacture superior products that set the “Gold Standard” for performance, safety, and quality.
- **Legendary Customer Service** – Marco's legendary customer service team is staffed by friendly, highly-trained individuals who are focused on providing the highest level of product support, order accuracy, and customer satisfaction.
- **Product Availability** – We stock over 10,000 SKU's and have more than 45 shipping locations to serve North American and International markets for all major brands of blasting and coating equipment. As the largest provider of surface preparation and protective coatings equipment in the world, our inventory levels and product availability are unmatched.
- **Logistics Services** – Marco's in-house logistics team is dedicated to moving your shipment anywhere in the world. We move more than 14,000 truckloads every year, allowing you to save on freight costs by leveraging our buying power. Lower your process costs with a single invoice, which includes product and freight.
- **Technology Leadership** – Our website provides: Operator's Manuals, Part Numbers and Schematics Guides, SDS information, and Features & Specifications Guides, providing access to information 24/7. Our Extranet application allows you to receive quotes and place orders online. Our Intranet maintains a complete record of your purchase history to assist with ongoing support of your existing equipment and future purchasing decisions.

Vision Statement

Marco is the world's premier provider of Abrasives, Blasting, Coating, Dust Collectors, Engineered Systems, Rental, Safety, Service, Repair, & Modernization, and Vacuums.

Mission Statement

Marco provides strong leadership and innovation to the surface preparation and protective coatings industries. We dedicate our efforts to the continuous improvement of our products, services, processes, people, and most importantly, the quality of our customer's experience.

Quality Statement

Marco is committed to providing superior quality in the design, manufacturing, distribution, rental, service, and repair of our products. Our ISO 9001:2008 certification extends throughout all operations in all locations. Continuous improvement of our processes and supply chain Integration comprise the core of our business strategy for delivering exceptional quality and value in all Marco products and services.





Management Philosophy

We are a company dedicated to the success of every customer and associate. We discuss, debate, challenge, measure, and test our ideas. We will be boundless and limitless in our passion to improve. Through sound leadership and dedicated associates, we will ensure a long term, profitable future for Marco, our associates, customers, and suppliers.

TABLE OF CONTENTS

Company Profile	2
Table of Contents	3
Barricade® CO Monitor	4-5
Part Numbers	4
Part Numbers & Schematics	5
Optional Accessories	6
Maintenance Notes	7

PART NUMBERS

Part Numbers		BARRICADE® CO MONITOR				
		Barricade® CO Monitor	12-Volt DC Power Cord	120-Volt AC Power Cord	5 Ft. x 3/8" I.D. Air Hose	Calibration Kit
	1050001	X				
	1050125	X	X			
	1050126	X	X		X	X
	1050130	X		X		
	1050131	X		X	X	X





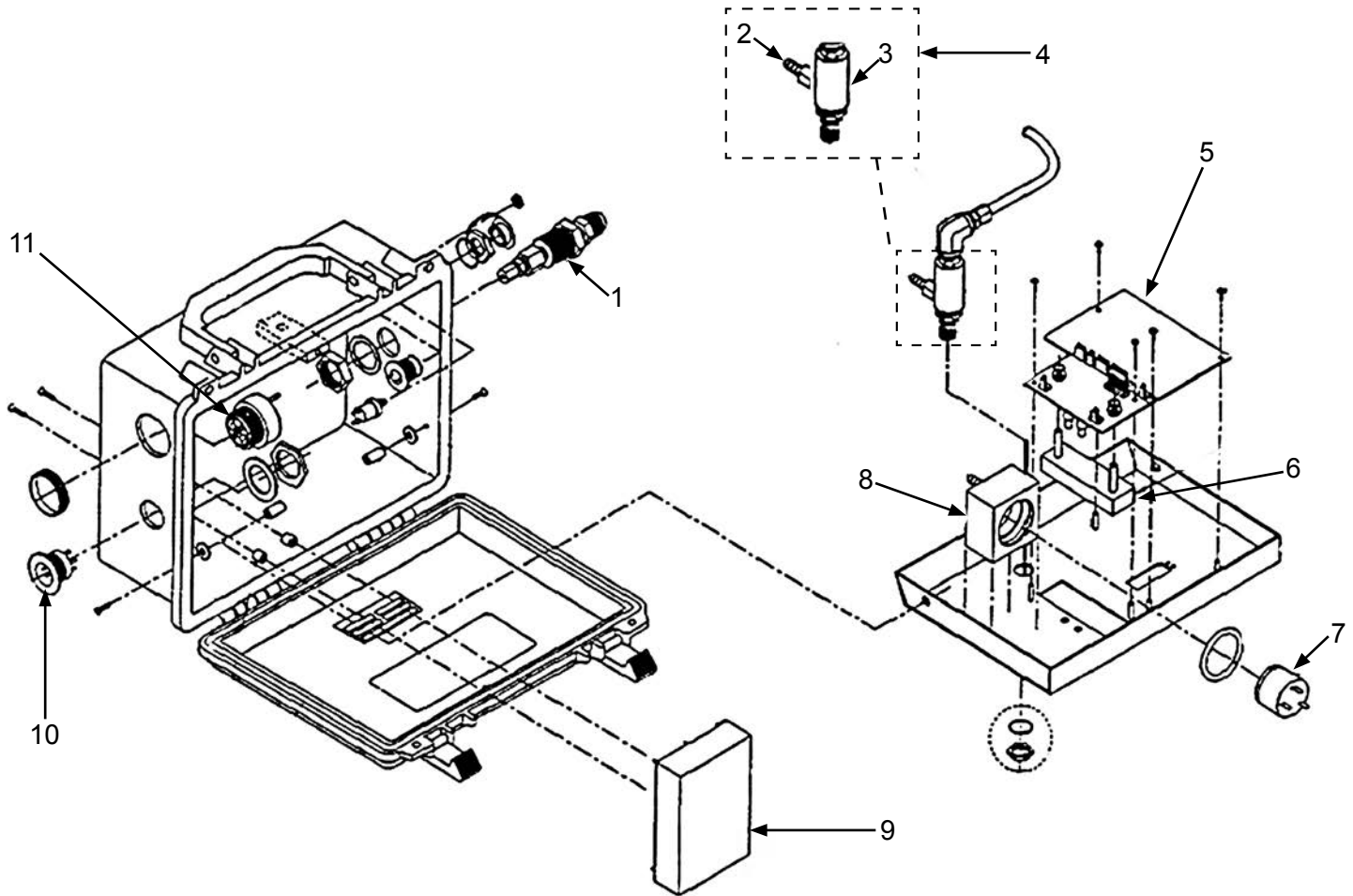









PART NUMBERS & SCHEMATICS

Figure 1: Barricade® CO Monitor



Item #	Part #	Description
Fig. 1		
1	1050117	Flow Screen
2	1050116	Flow Restrictor
3	1050115	Pressure Regulator
4	1050135	Regulator Kit (Includes Item #'s 2 and 3)
5	1050119	Circuit Board
6	1050113	Flow Meter
7	1050108	Sensor
8	1050112	Flow Block
9	1050121	Power Supply with Regulator
10	1050127	Female Plug Inlet
11	10501021	Alarm
—	1050120	Potentiometer Tool
—	105M022	Features & Specifications Guide – Barricade® CO Monitor
—	106M005	Part Numbers and Schematics Guide – Barricade® CO Monitor & Accessories
—	1090005	Operator's Manual – Barricade® CO Monitor

OPTIONAL ACCESSORIES

Part Numbers	BARRICADE® CO MONITOR ACCESSORIES	
	Description	
	1050139	12-Volt DC Power Cord – 100'
	1050102	12-Volt DC Power Cord – 110"
	1050103	120-Volt AC Power Cord – 94"
	1050110	External Strobe and Alarm with 20' Power Cord
	1050111	50' Extension Cord for 1050110 External Strobe and Alarm
	1050136	Calibration Kit Complete <i>(Includes: 1050105, 1050106, 1050114, 1050129, 1050120, and 1050122)</i>
	1050105	95 ppm Calibration Gas
	1050106	Zero Calibration Gas
	1069538	5' x 3/8" I.D. Air Hose for Hook-Up
	1050120	Potentiometer Tool For Calibration
	1050122	Calibration Gas Regulator Valve
	1050114	Calibration Adapter Fitting
	1050129	Hose For Calibration
	1030718	Battery Clamps

GLOBAL HEADQUARTERS

- 3425 East Locust Street
Davenport, IA 52803

ph: 800.BLAST.IT (800.252.7848)
ph: 563.324.2519
fax: 563.324.6258

REGIONAL BRANCH OFFICES

- **Iowa**
Davenport
- **Louisiana**
Gonzales
Harvey
Lafayette
- **Ohio**
Youngstown
- **Texas**
Beaumont
Corpus Christi
Deer Park

40+ NATIONWIDE SHIPPING LOCATIONS



★ Marco Regional Branch Offices and Shipping Locations ● Direct Shipping Locations



ABRASIVES

BLASTING

COATING

DUST COLLECTORS

ENGINEERED SYSTEMS

RENTAL

SAFETY

SERVICE, REPAIR, & MODERNIZATION

VACUUMS

CONTACT MARCO

800.BLAST.IT
(800.252.7848)
563.324.2519
FAX: 563.324.6258

WWW.MARCO.US
SALES@MARCO.US