



BLASTMASTER® 156E REMOTE CONTROL SWITCH



BUILT MARCO TOUGH
MARCO MANUFACTURED

PART NUMBERS AND SCHEMATICS GUIDE

Company Profile

Since 1944, Marco has developed a strong tradition of providing innovative and reliable products and services to the surface preparation and protective coatings industries. We are the world's premier provider of Abrasives, Blasting, Coating, Dust Collectors, Engineered Systems, Rental, Safety, Service, Repair, & Modernization, and Vacuums.

Through innovative designs and a total commitment to quality, Marco manufactures products that increase production rates, create a safer workplace, and reduce maintenance costs. Marco's industry experience, manufacturing capabilities, legendary customer service, product availability, logistics services, and technology leadership is your assurance that we deliver high quality products and services, providing the best value to you, our customer.

The Marco Difference

- **Industry Experience** – With Marco on your team, you have access to expertise which can only come from decades of industry leadership. We have organized our engineering department, production specialists, customer operations, and safety support into a “Center of Competence.” As a Marco customer, you have access to hundreds of years of cumulative experience related to your operations.
- **Manufacturing Excellence** – Marco is a manufacturer of equipment for the Surface Preparation and Protective Coatings industries. Marco's engineers benchmark the industry to ensure that we design and manufacture superior products that set the “Gold Standard” for performance, safety, and quality.
- **Legendary Customer Service** – Marco's legendary customer service team is staffed by friendly, highly-trained individuals who are focused on providing the highest level of product support, order accuracy, and customer satisfaction.
- **Product Availability** – We stock over 10,000 SKU's and have more than 45 shipping locations to serve North American and International markets for all major brands of blasting and coating equipment. As the largest provider of surface preparation and protective coatings equipment in the world, our inventory levels and product availability are unmatched.
- **Logistics Services** – Marco's in-house logistics team is dedicated to moving your shipment anywhere in the world. We move more than 14,000 truckloads every year, allowing you to save on freight costs by leveraging our buying power. Lower your process costs with a single invoice, which includes product and freight.
- **Technology Leadership** – Our website provides: Operator's Manuals, Part Numbers and Schematics Guides, SDS information, and Features & Specifications Guides, providing access to information 24/7. Our Extranet application allows you to receive quotes and place orders online. Our Intranet maintains a complete record of your purchase history to assist with ongoing support of your existing equipment and future purchasing decisions.

Vision Statement

Marco is the world's premier provider of Abrasives, Blasting, Coating, Dust Collectors, Engineered Systems, Rental, Safety, Service, Repair, & Modernization, and Vacuums.

Mission Statement

Marco provides strong leadership and innovation to the surface preparation and protective coatings industries. We dedicate our efforts to the continuous improvement of our products, services, processes, people, and most importantly, the quality of our customer's experience.

Quality Statement

Marco is committed to providing superior quality in the design, manufacturing, distribution, rental, service, and repair of our products. Continuous improvement of our processes and supply chain Integration comprise the core of our business strategy for delivering exceptional quality and value in all Marco products and services.

Management Philosophy

We are a company dedicated to the success of every customer and associate. We discuss, debate, challenge, measure, and test our ideas. We will be boundless and limitless in our passion to improve. Through sound leadership and dedicated associates, we will ensure a long term, profitable future for Marco, our associates, customers, and suppliers.

TABLE OF CONTENTS

Company Profile	2
Table of Contents	3
Blastmaster® 156E	
Remote Control Switches	4-7
Part Numbers	4
Blastmaster® 156E Remote Control Switch. . . .	5-7
Optional Accessories	6-7
Electric Control Lines	6
Electric Control Lines with Plugs	7
Electric Control Line Plugs	7

PART NUMBERS AND SCHEMATICS GUIDE

BLASTMASTER® 156E REMOTE CONTROL SWITCH			
Part Numbers	Body Material	Replaceable Switch	Electric Control Line Length
1015600	Urethane	Yes	4 Ft.



PART NUMBERS AND SCHEMATICS GUIDE

Figure 1: Blastmaster® 156E Remote Control Switch

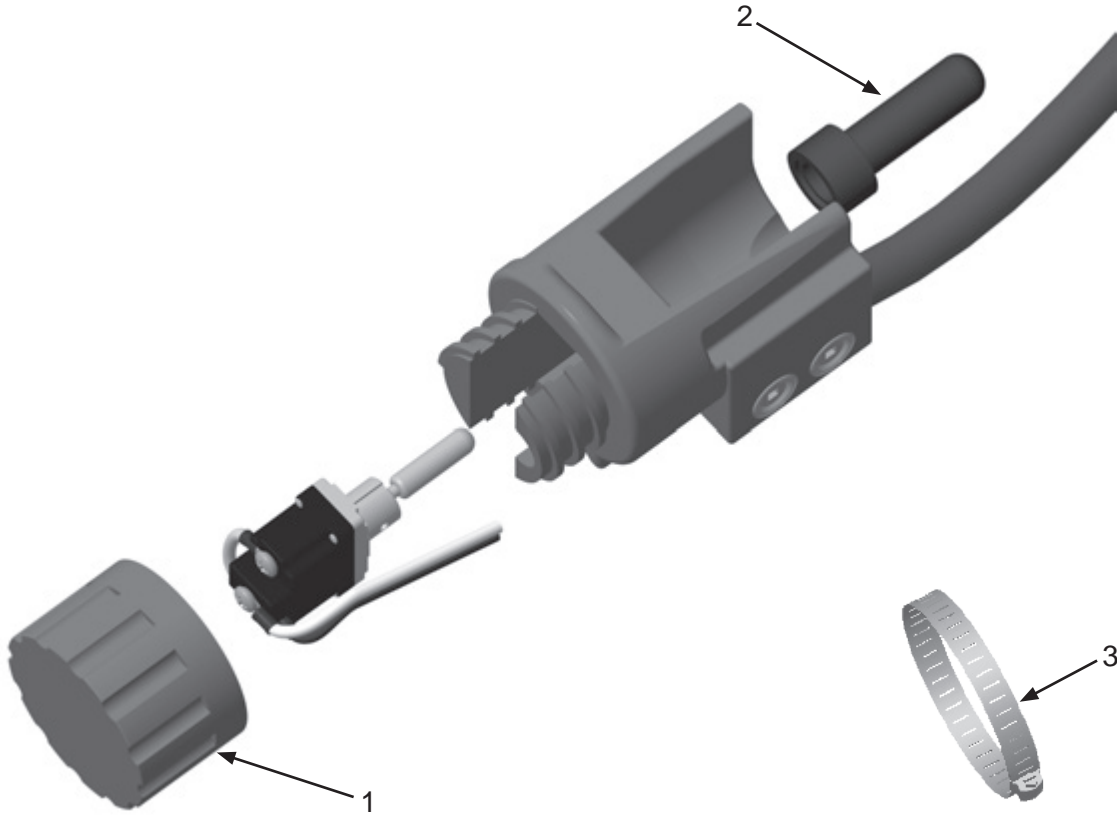

Item #	Part #	Description
Fig. 1		
—	1015600	Blastmaster® 156E Remote Control Switch – Complete
1	1015603	Cap
2	1015501	Toggle Boot
3	1015503	Hose Clamp
—	1015604	Repair Kit <i>(Includes Item #2, Toggle Switch, and 4 Feet of 16/2 cord)</i>
—	1015602	KwikChange Repair Kit <i>(Includes: Pre-Wired Toggle Switch with 4 Feet of Power Cord)</i>
—	1091045	Hazard Identification Tag
—	106M002	Part Numbers and Schematics Guide – Blastmaster® 156E Remote Control Switch
—	1090139	Operator's Manual – Blastmaster® 156E and Remote Control Switch

OPTIONAL ACCESSORIES











Part Numbers

ELECTRIC CONTROL LINES

	Gauge	# of Wires	Type	Length
1015540	16	2		Per Foot
1015701	16	3		Per Foot
1030013	14	2	SEOOW	Per Foot
1015550	14	3	SEOOW	Per Foot
1015554	14	4	SEOOW	Per Foot
1015570	12	2	SOOW	Per Foot
1015571	12	3	SJEOOW	Per Foot
1015581	10	3	SEOOW	Per Foot
1015580	10	4	SEOOW	Per Foot
1015591	8	3	SEOOW	Per Foot
1015590	8	4	SEOOW	Per Foot
1015595	6	3	SEOOW	Per Foot

OPTIONAL ACCESSORIES

		ELECTRIC CONTROL LINES WITH PLUGS				
	Part Numbers	Gauge	# of Wires	3-Prong Male Twist-Lock Plug	3-Prong Female Twist-Lock Plug	Length
	1015546	16	2	1015555	1015556	25 Feet
	1015545	16	2	1015555	1015556	50 Feet
	1015547	16	2	1015555	1015556	100 Feet
	1015748	16	3	1015555	1015556	13 Feet
	1015745	16	3	1015555	1015556	50 Feet
	1015747	16	3	1015555	1015556	110 Feet

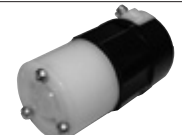
		ELECTRIC CONTROL LINE PLUGS	
	Part Numbers	Prong Style	Plug Style
	1015555	3-Prong Male	Twist-Lock
	1015556	3-Prong Female	Twist-Lock

40+ NATIONWIDE SHIPPING LOCATIONS

CONTACT CENTER

- 3425 East Locust Street
Davenport, IA 52803

ph: 800.BLAST.IT (800.252.7848)

ph: 563.324.2519

fax: 563.324.6258

REGIONAL BRANCH OFFICES

- **Iowa**
Davenport
- **Louisiana**
Gonzales
Lafayette
- **Ohio**
Youngstown
- **Texas**
Beaumont
Corpus Christi
Deer Park



★ Marco Regional Branch Offices and Shipping Locations ● Direct Shipping Locations



ABRASIVES
BLASTING
COATING
DUST COLLECTORS
ENGINEERED SYSTEMS
RENTAL
SAFETY
SERVICE, REPAIR
VACUUMS

CONTACT MARCO

800.BLAST.IT
(800.252.7848)
563.324.2519
FAX: 563.324.6258

WWW.MARCO.US
SALES@MARCO.US