

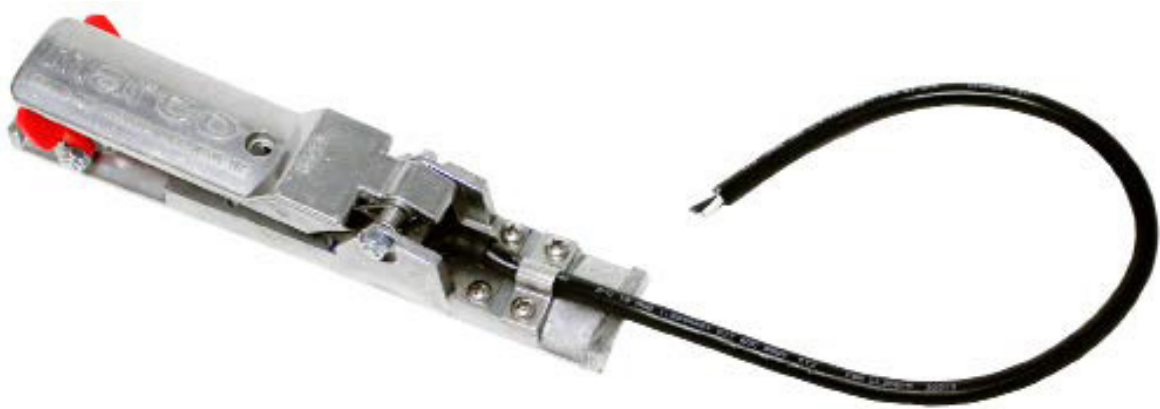

MARCO® 151E REMOTE CONTROL SWITCH



PART NUMBERS AND SCHEMATICS GUIDE

Company Profile

Allredi was formed in the early 2020, when two of the largest distributors in the blasting, coating, safety, and environmental industry, APE Companies and Marco Group International, joined forces. While the qualities both companies are known for have not changed, a lot about our business is new. New abilities. New agilities. New ways to help you win. This calls for a new name, Allredi.

This name exemplifies what we have become. It is completely oriented to the needs of our customers. To your needs. It says that when you call us for anything – products, service, expert advice, anything – you can consider it done. Or even better, Allredi done.

We are your right-now supplier. From skills to SKUs, we deliver the goods fast. So you can be more agile every minute, every day. This is who we are. This is what our new name means. Go ahead and expect excellence, because we're bringing it.

Our Mission and Vision

To be the industry's preferred partner in surface preparation solutions through unrivaled technical expertise, customer experience, product availability, and tailored service offerings.

The Allredi Difference

- **Industry Experience** – With Allredi on your team, you have access to expertise which can only come from decades of industry leadership. We have organized our engineering department, production specialists, customer operations, and safety support into a "Center of Competence." As an Allredi customer, you have access to hundreds of years of cumulative experience related to your operations.
- **Manufacturing Excellence** – Allredi is a U.S. based manufacturer of equipment for the Surface Preparation and Protective Coatings industries. Allredi's engineers benchmark the industry to ensure that we design and manufacture superior products that set the "Gold Standard" for performance, safety, and quality.
- **Legendary Customer Service** – Allredi's legendary customer service team is staffed by friendly, highly-trained individuals who are focused on providing the highest level of product support, order accuracy, and customer satisfaction.
- **Product Availability** – We stock over 10,000 SKU's and have over 45 shipping locations to serve North American and International markets for all major brands of blasting, coating, environmental, and safety equipment. Allredi is your right-now supplier, so you can keep your projects moving. From our foundation of strong relationships, we have built a nationwide network that puts vast inventory and ready service close to our customers. We provide advanced expertise, and we deliver the goods fast – so you can easily access the products and services you need to me more agile every minute, every day.
- **Technology Leadership** – Our website provides: Operator's Manuals, Part Numbers and Schematics Guides, SDS information, and key product features and specifications, providing access to information 24/7.

TABLE OF CONTENTS

Company Profile	2
Table of Contents	3
Marco® 151E Remote Control Switches	4-9
Part Numbers	4-5
Part Numbers and Schematics	6-7
Optional Accessories	8-10
Maintenance Notes	11

PART NUMBERS AND SCHEMATICS GUIDE

MARCO® 151E REMOTE CONTROL SWITCH				
Part Numbers	Body Material	Replaceable Switch	Electric Control Line Length	Plug
1015100	Aluminum	Yes	1.5 Ft.	None

PART NUMBERS AND SCHEMATICS GUIDE

Marco® 151E Remote Control Switch



PART NUMBERS AND SCHEMATICS GUIDE

Marco® 151E Remote Control Switch

Item #	Part #	Description
Fig. 1		
—	1015100	Marco® 151E Remote Control Switch – Complete
1	1015001	Handle
2	1015007	3/8" O.D. x 7/16" I.D. Washer (<i>Four Required</i>)
3	1015014	8-32 x 3/8" Phillips Head Screw (<i>Four Required</i>)
4	1015101	Electric Cord Clamp
5	1015006	8-32 UNC-2B Nylon Insert Lock Nut (<i>Two Required</i>)
6	10104268	Micro Switch
7	1015016	Nylon Zip Tie - White (<i>Two Required</i>)
8	1015002	Body
9	1015008	Shoulder Screw (<i>Two Required</i>)
10	1015005	Spring (<i>Two Required</i>)
11	1015003	Safety Tab
12	1015127	Female Low Profile 4-Pin Plug (<i>Optional</i>)
—	106M063	Part Numbers and Schematics Guide – Marco® 151E Remote Control Switch
—	1090063	Operator's Manual – Marco® 151E Remote Control Switch
—	1091045	Hazard Identification Tag

OPTIONAL ACCESSORIES

Figure 1: Marco® 151E Remote Control Switch

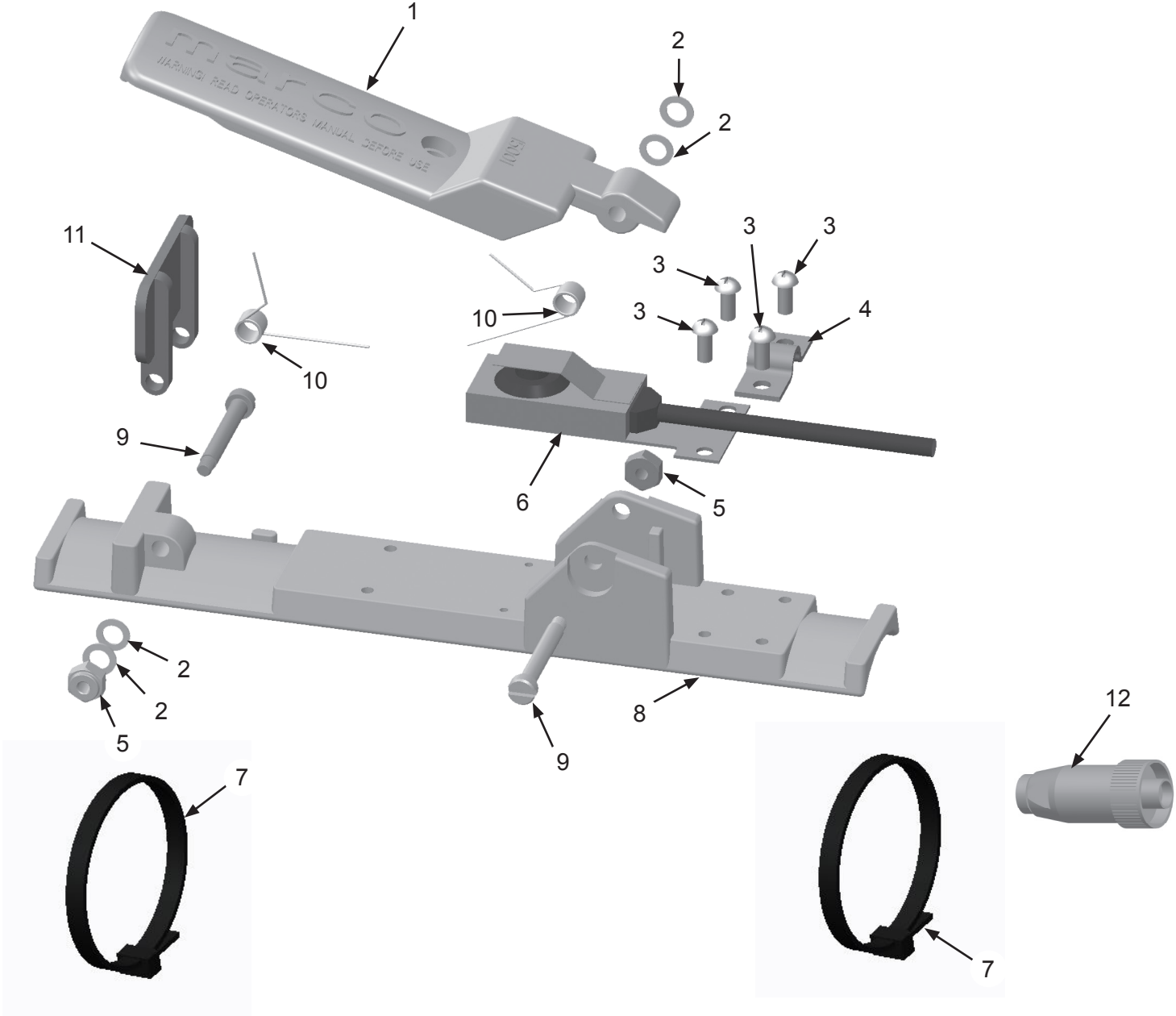

OPTIONAL ACCESSORIES











**Part
Numbers**







ELECTRIC CONTROL LINE

	Gauge	# of Wires	Type	Length
1015540	16	2		Per Foot
1015701	16	3		Per Foot
1030013	14	2	SEOOW	Per Foot
1015550	14	3	SEOOW	Per Foot
1015554	14	4	SEOOW	Per Foot
1015570	12	2	SOOW	Per Foot
1015571	12	3	SJEOOW	Per Foot
1015581	10	3	SEOOW	Per Foot
1015580	10	4	SEOOW	Per Foot
1015591	8	3	SEOOW	Per Foot
1015590	8	4	SEOOW	Per Foot
1015595	6	3	SEOOW	Per Foot

OPTIONAL ACCESSORIES

		ELECTRIC CONTROL LINE WITH PLUGS						
Part Numbers	Gauge	# of Wires	2-Prong Male Twist-Lock Plug	2-Prong Female Twist-Lock Plug	3-Prong Male Twist-Lock Plug	3-Prong Female Twist-Lock Plug	Length	
 1015543	16	2	1015551	1015552	—	—	25 Feet	
 1015542	16	2	1015551	1015552	—	—	50 Feet	
 1015546	16	2	—	—	1015555	1015556	25 Feet	
 1015545	16	2	—	—	1015555	1015556	50 Feet	
 1015547	16	2	—	—	1015555	1015556	100 Feet	
 1015748	16	3	—	—	1015555	1015556	13 Feet	
 1015745	16	3	—	—	1015555	1015556	50 Feet	
 1015747	16	3	—	—	1015555	1015556	110 Feet	

OPTIONAL ACCESSORIES

		ELECTRIC CONTROL LINE PLUGS	
Part Numbers		Prong Style	Plug Style
	1015551	2-Prong Male	Twist-Lock
	1015552	2-Prong Female	Twist-Lock
	1015555	3-Prong Male	Twist-Lock
	1015556	3-Prong Female	Twist-Lock
	1015126	4-Pin Male	Low-Profile
	1015127	4-Pin Female	Low-Profile

